

---

# User's Guide

---

HP 83751A/B and  
HP 83752A/B  
Synthesized Sweepers

HP part number: 83750-90004  
Printed in USA March 1996

**Serial Numbers.**

This manual applies directly to instruments with serial prefix 3610A and below.

This manual also applies to Ermware revision 2.0 and above. For Ermware revisions below 2.0 contact your nearest Hewlett-Packard service center for a Ermware upgrade.

**Notice.**

The information contained in this document is subject to change without notice.

Hewlett-Packard makes no warranty of any kind with regard to this material, including but not limited to, the implied warranties of merchantability and fitness for a particular purpose. Hewlett-Packard shall not be liable for errors contained herein or for incidental or consequential damages in connection with the furnishing, performance, or use of this material.

@Copyright Hewlett-Packard Company 1993, 1996  
All Rights Reserved. Reproduction, adaptation, or translation without prior written permission is prohibited, except as allowed under the copyright laws.  
1400 Fountaingrove Parkway, Santa Rosa, CA 95403, USA

---

# The HP 83751A/B and HP 83752A/B Synthesized Sweepers

The HP 83751A/B and HP 83752A/B synthesized sweepers (referred to as “sweepers” throughout this manual) provide continuous analog or digital stepped sweep capability. The HP 83751A/B provides a frequency range of 2 to 20 GHz, while the HP 83752A/B provides a frequency range of 10 MHz to 20 GHz. The “B” versions of both the HP 83751 and HP 83752 provide high power output (approximately + 17 dBm maximum leveled power). The sweepers are SCPI and HP-IB programmable, with HP 8350 HP-IB mnemonics for drop-in replacement of an HP 8350 sweep oscillator. The sweepers are designed for optimum use with HP 8757 scalar analyzers. For specification and option information, refer to Chapter 17, “Specifications and Options,” in this manual.

This User’s Guide is written to provide operating information to the user who is comfortable with the front panel layout and basic operation of the sweeper. For installation and basic sweeper operation, refer to the *HP 83751A/B and HP 83752A/B Synthesized Sweepers Installation and Quick Start Guide*, provided with your shipment.

---

# The Synthesized Sweeper at a Glance

The following Egre and accompanying text explain some features of the sweeper.

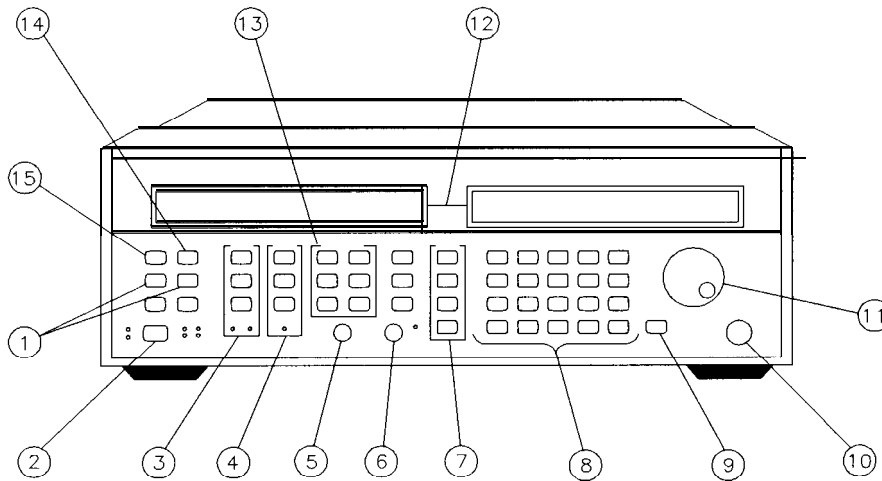

pg425ab

The Synthesized Sweeper

1. The **SAVE** and **RECALL** keys are used to save and subsequently recall sweeper operating parameters from one of nine nonvolatile register locations.
2. The line POWER switch turns the sweeper to either on or standby.
3. The Marker keys allow selection of up to ten markers to be set anywhere within the current frequency range. Marker **A** measurements are made using these keys as well.
4. The Modulation keys allow selection of pulse, AM, or FM modulation.
6. The SWEEP OUT BNC connector provides voltage proportional to the sweep ranging from 0 V at the start of a sweep to +10 V at the end of the sweep, regardless of sweep width.
6. The Automatic Level Control voltage input (ALC IN) connector is used as the feedback path to the sweeper when its RF output power level is being leveled externally.
7. The Power keys allow selection of the RF output power level of the sweeper, as well as other power related functions, such as Automatic Level Control (ALC). The **ALC MODE** key is used to select the method used to regulate the sweeper output power level. Either internal leveling or external leveling [with a diode, power meter, or source module] can be selected. Additional equipment is required when external leveling is used.
6. The date entry keys are used to enter and/or modify various sweeper parameters. The key cancels all or part of an erroneous parameter entry before it has been terminated. The terminator keys (the rightmost column of keys) are used to choose the units for the entered parameter as well as to terminate the parameter entry. The key, key, and **STEP SIZE** keys are used to increase or decrease a parameter in predetermined steps.
9. The **RF ON/OFF** key is used to toggle the RF output power on and off.
10. The RF OUTPUT connector mates with a female APC-3.5mm precision connector on standard instruments. The connector mates with a type-N male connector on option 1E0 instruments. The RF OUTPUT connector will be found on the rear panel of sweepers with option 1E4.
11. The front panel knob is used to increase or decrease active parameters under the pointers, and is used in manual frequency and power sweeps.
12. The displays show the current values of sweeper parameters as well as the status of many of the sweeper functions. The left-hand display shows the current frequency status, whether it be swept or CW. The right-hand display shows current marker, modulation and sweep status parameters when they are selected, as well as the current output power level. The annunciators that appear below the parameters are only visible when their associated function is active. For example, the **STEP** annunciator will only be visible when operating in stepped sweep mode.
13. The Frequency keys are used to set the various frequency parameters for the sweeper. Swept frequency selections include Start/Stop, CF/Span and Marker 1 → Marker 2 functions. Continuous Wave (CW) mode may also be selected for outputting single frequencies.
14. The **PRESET** key is used to put the instrument into a known state. There are two preset modes: the factory mode, and a user-defined mode.
15. The **SHIFT** key changes the function of some of the keys. When you press the **SHIFT** key and then press another key, the sweeper performs the function printed in blue above the key.

Sweeper rear panel features are depicted and described in detail in Chapter 7, “Front/Rear Panel” in this manual.

---

# In This Book

This book is divided into two sections: the task reference and the dictionary reference. These sections are subdivided into chapters. The task reference section (identified by light blue tabs) provides step-by-step instructions for many of the tasks that you perform with your sweeper. The chapters in the task reference section are as follows:

- Chapter 1 “Performing the Operator’s Check, ” contains a procedure for assuring you that your instrument is operating correctly.
- Chapter 2 “Externally Leveling the Sweeper, ” provides the steps necessary to externally level your sweeper with detectors/couplers/splitters, power meters, and source modules.
- Chapter 3 “Generating a Stepped Sweep,” explains how to set up the instrument to generate a stepped sweep.
- Chapter 4 “Generating a Millimeter Signal,” illustrates the setups for using a millimeter head with your option 1EE sweeper.
- Chapter 5 “Creating User Flatness Arrays,” explains how to create user flatness correction arrays, which calibrate the power level at a remote test port.
- Chapter 6 “Operating a Master/Slave Setup, ” shows the steps necessary to configure two sweepers for two-tone measurement capabilities.

The dictionary reference section (identified by dark blue tabs) provides information about instrument features and functions. Information is divided into chapters as follows:

- Chapter 7 “Front/Rear Panel, ” contains entries that explain different aspects of the sweeper front and rear panel. (For example, you turn to this chapter for information on the sweepers various connectors).
- Chapter 8 “Instrument State Keys,” explains the functions of the keys in the Instrument State group.
- Chapter 9 “Marker Keys, ” explains the functions of the keys in the Markers group.

- Chapter 10 “Modulation Keys,” explains the functions of the keys in the Mod group.
- Chapter 11 “Frequency Keys,” explains the functions of the keys in the Frequency group.
- Chapter 12 “Sweep Keys,” explains the functions of the keys in the Sweep group.
- Chapter 13 “Power Keys,” explains the functions of the keys in the Power group.
- Chapter 14 “Entry Keys,” explains the functions of the keys in the Entry group.
- Chapter 15 “Special Functions,” explains the various selections in the special functions menu, which is accessed by selecting **SHIFT** SPECIAL.
- Chapter 16 “Error Messages,” contains lists of the error messages that might be generated during use of the instrument.
- Chapter 17 “Specifications and Options,” contains a list of the sweeper’s warranted performance specifications and typical operating parameters, as well as the various mechanical, electrical, warranty, and documentation options that are available.
- Chapter 18 “Safety and Regulatory Information,” contains required regulatory and safety information that is not included elsewhere in the instrument documentation.

---

# Certification

Hewlett-Packard Company certifies that this product met its published specifications at the time of shipment from the factory. Hewlett-Packard further certifies that its calibration measurements are traceable to the United States National Institute of Standards and Technology, to the extent allowed by the Institute's calibration facility, and to the calibration facilities of other International Standards Organization members.

## **Regulatory Information.**

The "Safety and Regulatory Information" chapter contains regulatory information.



---

# Warranty

This Hewlett-Packard instrument product is warranted against defects in material and workmanship for a period of one year from date of shipment. During the warranty period, Hewlett-Packard Company will, at its option, either repair or replace products which prove to be defective.

For warranty service or repair, this product must be returned to a service facility designated by Hewlett-Packard. Buyer shall prepay shipping charges to Hewlett-Packard and Hewlett-Packard shall pay shipping charges to return the product to Buyer. However, Buyer shall pay all shipping charges, duties, and taxes for products returned to Hewlett-Packard from another country.

Hewlett-Packard warrants that its software and firmware designated by Hewlett-Packard for use with an instrument will execute its programming instructions when properly installed on that instrument. Hewlett-Packard does not warrant that the operation of the instrument, or software, or firmware will be uninterrupted or error-free.

## LIMITATION OF WARRANTY

The foregoing warranty shall not apply to defects resulting from improper or inadequate maintenance by Buyer, Buyer-supplied software or interfacing, unauthorized modification or misuse, operation outside of the environmental specifications for the product, or improper site preparation or maintenance.

NO OTHER WARRANTY IS EXPRESSED OR IMPLIED. HEWLETT-PACKARD SPECIFICALLY DISCLAIMS THE IMPLIED WARRANTIES OF MERCHANTABILITY AND FITNESS FOR A PARTICULAR PURPOSE.

## EXCLUSIVE REMEDIES

THE REMEDIES PROVIDED HEREIN ARE BUYER'S SOLE AND EXCLUSIVE REMEDIES. HEWLETT-PACKARD SHALL NOT BE LIABLE FOR ANY DIRECT, INDIRECT, SPECIAL, INCIDENTAL, OR CONSEQUENTIAL DAMAGES, WHETHER BASED ON CONTRACT, TORT, OR ANY OTHER LEGAL THEORY.

---

# Assistance

*Product maintenance agreements and other customer assistance agreements are available for Hewlett-Packard products.*

*For any assistance, contact your nearest Hewlett-Packard Sales and Service Office. Refer to the list of Sales and Service Offices on the following page.*

## Hewlett-Packard Sales and Service Offices

### IN THE UNITED STATES

#### California

Hewlett-Packard Co.  
1421 South Manhattan Ave  
P.O. Box 4230  
Fullerton, CA 92631  
17141 999-6700

Hewlett-Packard Co.  
301 E. Evelyn  
Mountain View, CA 94039  
14151 694-2000

#### Colorado

Hewlett-Packard Co.  
24 Inverness Place, East  
Englewood, CO 80112  
3031 649-5000

#### Georgia

Hewlett-Packard Co.  
2000 South Park Place  
P.O. Box 105005  
Atlanta, GA 30339  
4041 955-1500

#### Illinois

Hewlett-Packard Co.  
5201 Tollview Drive  
Rolling Meadows, IL 60008  
3121 255-9800

#### New Jersey

Hewlett-Packard Co.  
120 W. Century Road  
Paramus, NJ 07653  
201 265-5000

#### Texas

Hewlett-Packard Co.  
130 E. Campbell Rd.  
Richardson, TX 75081  
2141 231-6101

### IN AUSTRALIA

Hewlett-Packard Australia Ltd.  
31-41 Joseph Street  
Blackburn, Victoria 3130  
895-2895

### IN CANADA

Hewlett-Packard (Canada) Ltd.  
17500 South Service Road  
Trans-Canada Highway  
Kirkland, Quebec H9J 2X8  
15141 697-4232

### IN FRANCE

Hewlett-Packard France  
F-91947 Les Ulis Cedex  
Orsay  
(6) 907-78-25

### IN GERMAN FEDERAL REPUBLIC

Hewlett-Packard GmbH  
Vertriebszentrale Frankfurt  
Berner Strasse 117  
Postfach 560 140  
D-6000 Frankfurt 56  
1061 11 50-04-1

### IN GREAT BRITAIN

Hewlett-Packard Ltd.  
King Street Lane  
Winnersh, Wokingham  
Berkshire RG115AR  
0734 784774

### IN OTHER EUROPEAN COUNTRIES

Hewlett-Packard (Schweiz) AG  
Allmend 2  
CH-8967 Widen [Zurich]  
100411 57 31 21 11

### IN JAPAN

Yokogawa-Hewlett-Packard Ltd.  
29-21 Takaido-Higashi, 3 Chome  
Suginami-ku Tokyo 168  
(03) 331-6111

### IN PEOPLE'S REPUBLIC OF CHINA

China Hewlett-Packard, Ltd.  
P.O. Box 9610, Beijing  
4th Floor, 2nd Watch Factory  
Main Bldg.  
Shuang Yu Shu, Bei San Huan Rd.  
Beijing, PRC  
256-6888

### IN SINGAPORE

Hewlett-Packard Singapore  
Pte. Ltd.  
1150 Depot Road  
Singapore 0410  
273 7388  
Telex HPSGSO RS34209  
Fax (65) 2788990

### IN TAIWAN

Hewlett-Packard Taiwan  
8th Floor, Hewlett-Packard  
Building  
337 Fu Hsing North Road  
Taipei  
(02) 712-0404

### IN ALL OTHER LOCATIONS

Hewlett-Packard Inter-Americas  
3495 Deer Creek Rd.  
Palo Alto, California 94304

---

# Safety Notes

The following safety notes are used throughout this manual. Familiarize yourself with each of the notes and its meaning before operating this instrument.

---

## CAUTION

---

The *caution* note denotes a hazard. It calls attention to a procedure which, if not correctly performed or adhered to, could result in damage to or destruction of the instrument. Do not proceed beyond a *caution* note until the indicated conditions are fully understood and met.

---

## WARNING

---

The *warning* note denotes a hazard. It calls attention to a procedure which, if not correctly performed or adhered to, could result in **injury** or loss of life. Do not proceed beyond a *warning* note until the indicated conditions are fully understood and met.

### Instrument Markings.

---

#### Instruction Manual



The **instruction manual** symbol. The product is marked with this symbol when it is necessary for the user to refer to the instructions in the manual.

---

---

The **CE93** mark shows compliance with European Community 1993 standards.

---

---

The **CSA** mark is the Canadian Standards Association safety mark.

---

---

The **ISM1-A** mark stands for Industrial Scientific and Medical Group 1, Class A.

---

---

# General Safety Considerations

---

**WARNING**

*Before this instrument is switched on*, make sure it has been properly grounded through the protective conductor of the ac power cable to a socket outlet provided with protective earth contact.

This is a Safety Class I product (provided with a protective earthing ground incorporated in the power cord). Any interruption of the protective (grounding) conductor, inside or outside the instrument, or disconnection of the protective earth terminal can result in personal injury.

---

---

**WARNING**

No operator serviceable parts inside the instrument. Refer servicing to qualified personnel. To prevent electrical shock, do not remove covers. Any adjustments or service procedures that require operation of the instrument with protective covers removed should be performed only by trained service personnel.

---

---

**WARNING**

For continued protection against fire hazard, replace line fuse only with the same type and rating (F 6.3A/250V). The use of other fuses or material is prohibited.

---

---

**CAUTION**

If this instrument is used in a manner not specified by Hewlett-Packard Co., the protection provided by the instrument may be unpaired.

---

---

**CAUTION**

Always use the three-pronged ac power cord supplied with this instrument. Failure to ensure adequate earth grounding by using this cord may cause instrument damage.

---

---

**CAUTION**

This instrument has automatic selection input. Be sure the supply voltage is within the specified range.

---

---

# How to Use This Guide

## **This guide uses the following conventions.**

<b>FRONT-PANEL KEY</b>	This represents a key physically located on the instrument.
SHIFT FUNCTION	This represents a shift function (blue text above front panel keys).
Display	Text in this font represents FREQUENCY, MARKER/SWEEP/STATUS, and POWER displays.
ANNUNCIATOR	Text in this font represents the annunciators that are displayed in the lower portion of the sweeper display.

---

# Contents

<b>1. Performing the Operator's Check</b>	
To run the full self-test . . . . .	1-3
To run peak power-tracking . . . . .	1-5
To check the maximum leveled power . . . . .	1-6
To check the output power . . . . .	1-8
If you have a problem . . . . .	1-10
If the self-test fails . . . . .	1-10
If the maximum leveled power check fails . . . . .	1-11
<b>2. Externally Leveling the Sweeper</b>	
Leveling with detectors/couplers/splitters . . . . .	2-3
External leveling with the option 1E1 step attenuator . . . . .	2-6
See also . . . . .	2-6
Leveling with a power meter . . . . .	2-7
See also . . . . .	2-8
Leveling with millimeter-wave source modules (option 1EE only) . . . . .	2-9
See also . . . . .	2-11
<b>3. Generating a Stepped Sweep</b>	
<b>4. Generating a Millimeter Signal</b>	
Using millimeter heads with "B" model (high power) sweepers . . . . .	4-3
Using millimeter heads with "A" model (standard power) sweepers . . . . .	4-5
See also . . . . .	4-6
<b>5. Creating User Flatness Arrays</b>	
Creating a user flatness array . . . . .	5-3
To set up the sweeper . . . . .	5-4
To set up the power meter . . . . .	5-5
To start the user flatness cal . . . . .	5-5
Creating a user flatness array for use in a scalar analysis measurement . . . . .	5-6
To set up the sweeper . . . . .	5-7

To set up the analyzer . . . . .	5-7
To set up the power meter . . . . .	5-8
To start the user flatness cal . . . . .	5-8
To reactivate the HP 8757 system interface . . . . .	5-9
<b>6. Operating a Master/Slave Setup</b>	
To set up the master sweeper . . . . .	6-4
To set up the slave sweeper . . . . .	6-6
See also . . . . .	6-7
<b>7. Front/Rear Panel</b>	
Connectors . . . . .	7-3
BNC Connectors . . . . .	7-5
Multi-pin Connectors . . . . .	7-8
AUXILIARY INTERFACE . . . . .	7-8
HP-IB . . . . .	7-10
SOURCE MODULE INTERFACE (Option 1EE Only)	7-13
RF Output Connector . . . . .	7-15
Display . . . . .	7-16
Frequency Display . . . . .	7-17
Marker/Sweep/Status and Power Display . . . . .	7-18
Annunciators . . . . .	7-19
HP-IB Lang/Address Switch . . . . .	7-23
See Also . . . . .	7-25
Knob . . . . .	7-26
Equivalent SCPI Commands . . . . .	7-26
Line POWER Switch . . . . .	7-27
Power Cables . . . . .	7-29
<b>8. Instrument State Keys</b>	
SHIFT . . . . .	8-3
PRESET . . . . .	8-4
SAVE . . . . .	8-6
RECALL . . . . .	8-8
LOCAL . . . . .	8-10
MSG . . . . .	8-11



<b>9. Marker Keys</b>	
MKR n	9-4
OFF	9-7
MKR Δ	9-8
<b>10. Modulation Keys</b>	
PULSE MODE ↑↓	10-4
AM MODE ↑↓	10-6
FM MODE ↑↓	10-7
<b>11. Frequency Keys</b>	
START	11-4
STOP	11-6
CF	11-8
SPAN	11-9
CW	11-10
M1→M2/SWEEP	11-12
<b>12. Sweep Keys</b>	
TIME	12-4
TRIG MODE ↑↓	12-7
SINGLE/TRIG	12-10
<b>13. Power Keys</b>	
POWER LEVEL	13-3
POWER/SWEEP	13-5
ALC MODE ↑↓	13-7
FLTNESS ON/OFF	13-10
<b>14. Entry Keys</b>	
↑ ↓	14-3
STEP SIZE	14-4
Number Pad Keys	14-5
Unit Keys	14-6
RF ON/OFF	14-7
⇒ ⇐	14-8
ENTRY OFF	14-9
PEAK	14-10

## 15. Special Functions

1 - CWCF AUTO . . . . .	15-6
2 - CW PEAKNG . . . . .	15-7
3 - SWPTIME AUTO . . . . .	15-8
4 - STEP SWPTIME . . . . .	15-9
5 - SWPTIME LLIM . . . . .	15-10
6 - ATT COUPLING . . . . .	15-11
7 - ATT SETTING . . . . .	15-12
8 - ROSC AUTO . . . . .	15-13
9 - ROSC SOURCE . . . . .	15-14
10 - V/GHz SCALE . . . . .	15-15
11 - V/GHz OFFSET . . . . .	15-16
12 - PWR METER TY . . . . .	15-17
13 - PWR METER AD . . . . .	15-18
14 - FM SENSITIVITY . . . . .	15-19
15 - LANGUAGE . . . . .	15-20
16 - FW REVISION . . . . .	15-21
17 - *SECURITY . . . . .	15-22
18 - DP DEFIN . . . . .	15-26
19 - CONTROL MODE . . . . .	15-27
21 - FULL SELFTST . . . . .	15-28

## 16. Error Messages

The Error/Event Queue . . . . .	16-3
Error numbers . . . . .	16-4
Error Messages List . . . . .	16-5
SCPI Error Messages . . . . .	16-7
Command Error . . . . .	16-7
Execution Error . . . . .	16-13
Device-specific Error . . . . .	16-19
Query Error . . . . .	16-21
Instrument Specific Error Messages . . . . .	16-23
Block Transfer Errors . . . . .	16-23
Bus Control Errors . . . . .	16-24
Parsing and Compatibility Errors . . . . .	16-25
Diagnostics and Self-test Errors . . . . .	16-28
Internal Hardware Errors . . . . .	16-32
Hardware Configuration Errors . . . . .	16-32
Calibration Routine Errors . . . . .	16-33
Loops Unlocked Errors . . . . .	16-35
Miscellaneous Hardware Dependent Errors . . . . .	16-36

<b>17. Specifications and Options</b>	
Specifications . . . . .	17-3
Frequency . . . . .	17-4
Range . . . . .	17-4
Timebase Stability . . . . .	17-4
CW Mode . . . . .	17-4
Stepped Sweep Mode . . . . .	17-5
Ramp (Analog) Sweep Mode . . . . .	17-5
Bandswitch Points . . . . .	17-5
RF Output . . . . .	17-7
Maximum Leveled Power (25 ±5 °C) . . . . .	17-7
Minimum Settable Power . . . . .	17-8
Resolution . . . . .	17-8
Accuracy and Flatness . . . . .	17-8
Power Sweep . . . . .	17-9
Power Slope . . . . .	17-9
External Leveling . . . . .	17-9
User Flatness (Level) Correction . . . . .	17-9
Source Match . . . . .	17-10
Spectral Purity . . . . .	17-11
Harmonics (at max leveled power) . . . . .	17-11
Subharmonics . . . . .	17-11
Non-harmonic Spurious . . . . .	17-11
Residual FM (0.05 to 15 kHz bandwidth) . . . . .	17-12
Modulation . . . . .	17-13
Pulse . . . . .	17-13
AM . . . . .	17-13
FM . . . . .	17-14
General . . . . .	17-15
Compatibility . . . . .	17-15
Programming . . . . .	17-15
Master/Slave (two-tone) Measurements . . . . .	17-15
Environmental . . . . .	17-16
Warmup Time . . . . .	17-16
Power Requirements . . . . .	17-17
Dimensions . . . . .	17-17
Weight . . . . .	17-18
Options . . . . .	17-19
Electrical Options . . . . .	17-19
Option 1E1 - Add Output Step Attenuator . . . . .	17-19
Option 1E4 - Rear Panel RF Output . . . . .	17-19

Option 1E5 - Add High Stability Timebase . . . . .	17-19
Option 1ED - Type-N RF Output Connector . . . . .	17-19
Option 1EE - Source Module Connector and Extension Cable . . . . .	17-20
Mechanical Options . . . . .	17-20
Option 1CM - Rack Mount Kit without Handles . . .	17-20
Option 1CP - Rack Mount Kit with Handles . . . .	17-20
Option AX2 - Portable Handle and Front-panel Cover	17-20
Warranty Options . . . . .	17-21
Option W30 - Two Additional Rears Return-to-HP Service . . . . .	17-21
Option W50 - Five Year Return to HP Repair Service	17-21
Option W52 - Five Year Return-to-HP Calibration Service . . . . .	17-21
Option W54 - Five Year MIL-STD Calibration Service	17-21
Documentation Options . . . . .	17-22
Option OB2 - Extra Operating Documentation . . .	17-22
Option OB3 - Service Documentation . . . . .	17-22
Certification Options . . . . .	17-22
Option 1BN - Certification . . . . .	17-22
Option 1BP - Certification with Data . . . . .	17-22

**18. Safety and Regulatory Information**

Regulations and Licensing . . . . .	18-3
Notice for Germany: Noise Declaration . . . . .	18-3
Safety Information . . . . .	18-8
Statement of Compliance . . . . .	18-8
Environmental Conditions . . . . .	18-8
Ventilation Requirements . . . . .	18-9
Cleaning Instructions . . . . .	18-9

**Index**

---

# Figures

1-1. The UNLEV Annunciator Location . . . . .	1-7
1-2. Connections for Checking Output Power . . . . .	1-8
2-1. ALC Circuit Externally Leveled . . . . .	2-3
2-2. Typical Diode Detector Response at 25 °C . . . . .	2-5
2-3. Leveling with a Power Meter . . . . .	2-7
2-4. Millimeter-wave Source Module Leveling . . . . .	2-9
2-5. Millimeter-wave Source Module Leveling Using a Microwave Amplifier . . . . .	2-10
4-1. Millimeter-wave Source Module Leveling . . . . .	4-4
4-2. Millimeter-wave Source Module Leveling Using a Microwave Amplifier . . . . .	4-6
5-1. Creating a User Flatness Array . . . . .	5-3
5-2. Scalar Measurement System Setup . . . . .	5-6
6-1. Master/Slave Setup . . . . .	6-3
7-1. Sweeper Connectors - Front Panel . . . . .	7-3
7-2. Sweeper Connectors - Rear Panel . . . . .	7-4
7-3. Auxiliary Interface Connector . . . . .	7-8
7-4. HP-IB Connector and Cable . . . . .	7-10
7-5. Interface Signals of the Source Module Connector . . . . .	7-13
7-6. Sweeper Display . . . . .	7-16
7-7. Sweeper Display and LED Annunciators . . . . .	7-19
7-8. HP-IB Address Switch Settings . . . . .	7-23
7-9. Instrument Language Switch Settings . . . . .	7-24
7-10. Clear Register Contents Settings . . . . .	7-24
7-11. The Sweeper Line POWER Switch . . . . .	7-27
7-12. Power Cable and Line (Mains) Plug Part Numbers . . . . .	7-30
8-1. Instrument State Group . . . . .	8-2
9-1. The Markers Group . . . . .	9-2
10-1. The Modulation Group . . . . .	10-2
11-1. The Frequency Group . . . . .	11-2
12-1. The Sweep Group . . . . .	12-2
13-1. The Power Group . . . . .	13-2
14-1. The Entry Group . . . . .	14-2
15-1. The Instrument Group . . . . .	15-2
17-1. Typical Swept Frequency Accuracy (100 ms sweep, ramp mode) . . . . .	17-6
17-2. Typical Maximum Available Power . . . . .	17-7

Contents

17-3. Typical Phase Noise (10 GHz Carrier) . . . . .	17-12
17-4. Dimensions . . . . .	17-17

---

# Tables

7-1. Pin Description of the Auxiliary Interface . . . . .	7-9
8-1. Factory Preset Conditions . . . . .	8-4
14-1. Step Sizes . . . . .	14-3
15-1. Special Functions for the HP 83750 Series Sweepers . . . . .	15-4
15-2. FM Sensitivity When Using Source Modules . . . . .	15-19

---

## Performing the Operator's Check



---

# Performing the Operator's Check

The operator's check consists of a series of tasks that, when completed, will either assure you that your instrument is operating correctly, or will help to point to problem areas if it is not. The operator's check *does not* ensure performance to specifications.

The operator's check should be performed on a weekly basis, or whenever the integrity of the sweeper is in question.

To perform the operator's check, the following tasks should be performed, in order:

1. Run the full self-test.
2. Run peak power-tracking.
3. Check the maximum leveled power.
4. Check the output power.

---

## To run the full self-test

### Attention!

All external cables (including HP-IB and BNC cables) must be disconnected from the sweeper prior to running the full self-test. Failure to do so may cause self-test failures or lock-ups.

1. Disconnect all external cables prior to running the self-test.
2. Activate the FULL SELFTST special function by pressing the following keys on the sweeper:

**PRESET**

**SHIFT SPECIAL**

**21 Hz/s/ENTER**

The message that appears in the MARKER/SWEEP/STATUS display is one of the following:

Full Test NOTRUN

Full self-test has not been performed since the last time the line power was turned on.

Full Test PASSED

Full self-test has been performed and passed all tests.

--> XXXXXX

Full self-test has been performed, and test XXXXXX was either the only test that failed, or was the most significant failure.

3. Press the **Hz/s/ENTER** key again to initiate the self-test routine.

While the self-test routine is running, a \*\*\*\*\* i t \*\*\*\*\* message will appear in the MARKER/SWEEP/STATUS display.

**To run the full self-test**

4. When the self-test routine is finished, a message will appear in the MARKER/SWEEP/STATUS display. If the message does not say "Full Test PASSED," refer to the section entitled "If You Have a Problem" at the end of this chapter.

The full self-test is actually a series of tests performed to check different instrument functions. If the sweeper fails just one test, the display shows the title of the failed test. If the instrument fails more than one test, the test title shown is the most significant failure.

---

## To run peak power-tracking

1. Before running peak power-tracking, make sure the RF OUTPUT is either connected in a 50  $\Omega$  system, or has a load on it, such as a power sensor or attenuator.

---

### CAUTION

---

For optimum power at all frequencies, do not run peak power-tracking with a millimeter head connected to the sweeper.

2. Press (PRESET) (SHIFT) PEAK .

The MARKER/SWEEP/STATUS display shows the progression of the sweep as the instrument adjusts the power-tracking.

When you run peak power-tracking (or autotracking), the instrument optimizes its output power over the sweeper's full frequency range by tracking the output filter with the RF source output.

### NOTE

Peak power tracking takes approximately 1 to 3 minutes to complete, and can be aborted by pressing (PRESET), if necessary.

---

## To check the maximum leveled power

1. Before checking maximum leveled power, make sure the RF OUTPUT is either connected in a 50  $\Omega$  system, or has a load on it, such as a power sensor or attenuator.
2. Press **[PRESET]**.
3. Press **[POWER LEVEL]** and enter the specified maximum leveled power for your instrument. (For an HP 83752B, set the power to the specification for < 2 GHz.)

<b>Instrument</b>	<b>Maximum Leveled Power Specification</b>
H P 83751A/83752A	+ 10 dBm
HP 837518"	+ 17 dBm
H P 83752B*	
< 2 GHz	+ 16 dBm
$\geq$ 2 GHz	+ 17 dBm

\* Option 1E1 (step attenuator), reduce by 1 dB.

4. Make sure the UNLEV annunciator is not lit at any time. The UNLEV annunciator is located in the POWER display area. (See Figure 1-1.)
5. Press **[TIME]** **[2]** **[Hz/s/ENTER]** to change the sweep time to 2 seconds.
6. Press **[SINGLE TRIG]** and make sure the UNLEV annunciator does not come on at any point during the sweep. (If the annunciator comes on, it indicates the instrument is unleveled.) The UNLEV annunciator is located in the POWER display area. (See Figure 1-1.)

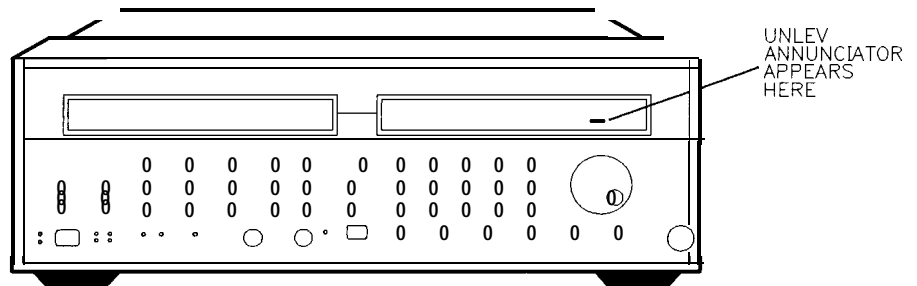

pg426ab

Figure I-1. The UNLEV Annunciator location

**For HP 83752B Instruments Only.**

The HP 83752B sweepers have a power specification that is split at 2 GHz.

7. Press the following keys to set a sweep range of 2 GHz to 20 GHz and a power level of 17 dBm (or 16 dBm for instruments with option 1E1):

**START** **2** **GHz/dB(m)**  
**POWER LEVEL** **17** (or **16**) **GHz/dB(m)**

8. Press **SINGLE TRIG** and make sure the UNLEV annunciator does not come on at any point during the sweep. (If the annunciator comes on, it indicates the instrument is unlevelled.) The UNLEV annunciator is located in the POWER display area. (See Figure I-1.)

# To check the output power

1. Connect the equipment as shown.

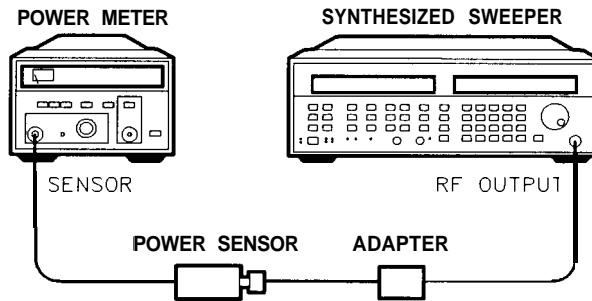

pg427ab

Figure 1-2. Connections for Checking Output Power

2. Press (PRESET).
3. Press (CW) (20) (GHz/dB(m)).
4. Press (POWER LEVEL) and enter the specified power for the CW frequency you set. Refer to the following table. Terminate the power level entry by pressing (GHz/dB(m)).

Instrument	Maximum leveled Power Specification
HP 83751A/83752A*	+10 dBm
HP 837518"	+17 dBm
HP 837528"	
< 2 GHz	+16 dBm
≥ 2 GHz	+17 dBm
* Option 1E1 (step attenuator), reduce by 1 dB.	

5. Set the power meter calibration factor to the value listed on the power sensor that corresponds to the frequency you set.
6. Verify that the measured output power meets the instrument specification.
  - If the measured value is less than the specified power, turn the front panel knob until the value measured is at least the specified power level.
  - Make sure that the UNLEV annunciator doesn't light. (If the annunciator does light, this indicates an unlevelled condition.)
7. Repeat steps 3 through 6 for the following setting(s):
  - 2.5 GHz
  - 1.5 GHz - for HP 83752A/B instruments only
  - 50 MHz - for HP 83752A/B instruments only



---

## If you have a problem

If you have a problem while performing the operator's check, check the following list of commonly encountered problems. If the problem you have encountered is not here, contact the nearest Hewlett-Packard office for assistance.

---

### If the self-test fails

The self-test has failed if the message that appears when it is done, is anything except `Full Test. PASSED`.

- ❑ Make sure all external cables are disconnected from the sweeper and run the self-test again.
- ❑ If the test still fails, send the instrument to an HP service center for repair, including a description of the failed test and any other error messages.

**N O T E**

If you need to ship your sweeper, remove the front handles (if so equipped) and use the original packaging (or comparable).

---

## If the maximum leveled power check fails

- ❑ Make sure that the RF OUTPUT connector was terminated before the peak power-tracking sequence was run, and before the maximum leveled power check.
- ❑ Make sure the power you entered in steps 2 and 5 of the maximum leveled power check procedure are correct for your particular instrument.
- ❑ If the measured value of power in step 6 of “To check the output power” is *more* than the specified power, turn the front panel knob counterclockwise until the value measured equals the specified power. Note the sweeper's front panel reading and use this value to repeat the maximum leveled power check.
- ❑ If the check still fails, contact the nearest Hewlett-Packard office for assistance.

**NOTE**

If you need to ship your sweeper, remove the front handles (if so equipped) and use the original packaging (or comparable).

---

## Externally Leveling the Sweeper

---

# Externally Leveling the Sweeper

In externally leveled operations, the output power from the sweeper is detected by an external sensor. The output of this detector is returned to the leveling circuitry, and the output power is automatically adjusted to keep power constant at the point of detection.

---

# Leveling with detectors/couplers/splitters

1. Connect the equipment as shown in Figure 2-1.

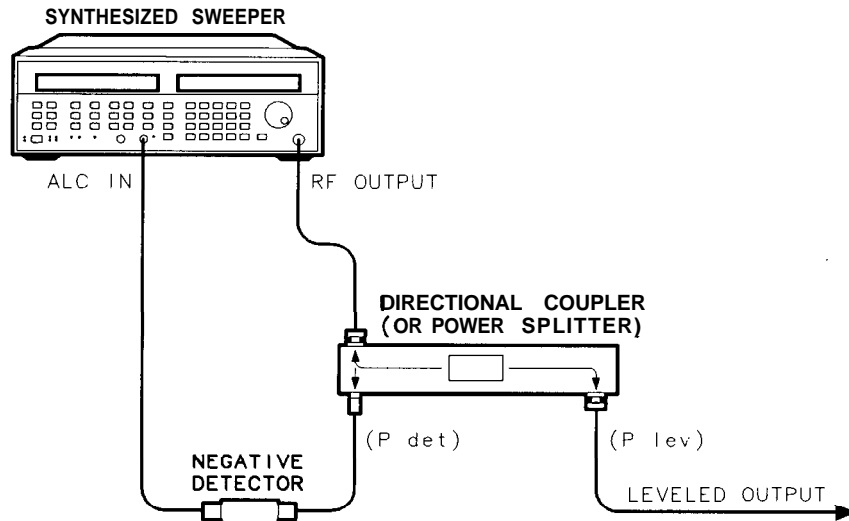

pg417ab

Figure 2-1. ALC Circuit Externally leveled

2. Press **ALC MODE** repeatedly until the MARKER/SWEEP/STATUS display shows **ALC= Diode**. Note that the EXT ALC annunciator is lit.
3. Enter the coupling factor by selecting **SHIFT** EXT CAL and then entering the desired number.

**NOTE**

The coupling factor (in dB) is defined by the equation  
**leveled power (P lev) – detected power (P det)**. Refer to Figure 2-1 for locations of **P lev** and **P det**. After the coupling factor has been entered, the front panel knob may be used to fine tune the displayed power to equal the actual leveled output power (**P lev**).

Figure 2-1 illustrates a typical setup for external leveling. When externally leveled, the power level feedback is taken from the external negative detector input rather than the internal detector. This feedback voltage controls the ALC system to set the desired RF output.

Figure 2-2 shows the input power versus output voltage characteristics for typical HP diode detectors. From the chart, the leveled power at the diode detector input resulting from any external level voltage setting may be determined. The ALC feedback voltage present at the output of the detector must be between -0.2 mV and -0.5 V. For a typical HP diode detector, this corresponds to a detector input of approximately -35 dBm to +5 dBm. (See Figure 2-2.)

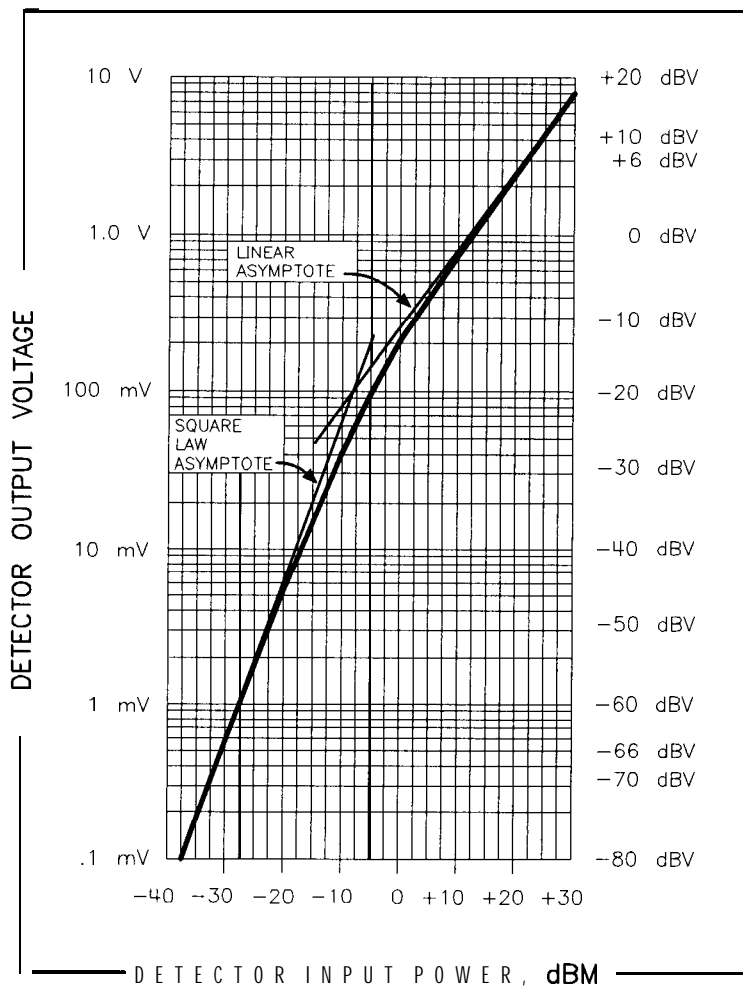

pg431ob

Figure 2-2. Typical Diode Detector Response at 25 °C

## External leveling with the option 1E1 step attenuator

Some external leveling applications require low output power from the sweeper. The sweeper automatically uncouples the attenuator from the ALC system for *all* external leveling points. Note that in external leveling modes, the UNCLPD annunciator is lit.

For example, leveling the output of a 30 dB gain amplifier to a level of -10 dBm requires the output of the sweeper to be around -40 dBm when leveled. At some frequencies this level is beyond the range of the ALC modulator alone. If so, the UNLEV warning message is displayed. Inserting 40 dB of attenuation results in an ALC level (power level + attenuator value) of 0 dBm, which is well within the range of the ALC. This gives a margin for AM or other functions that vary the power level.

The ALC level should be greater than or equal to -10 dBm for “A” model sweepers (standard power), and -5 dBm for “B” model sweepers (high power). Adjust the attenuator so that the ALC level is within the specified power range of your sweeper. For an “A” model sweeper, this is achieved by using attenuation equal to the tens digit of output power. Example: for a desired sweeper output power of -43 dBm; do the following:

1. Press **SHIFT** **SPECIAL** **7**
2. Set the attenuator to 40 dB: press **40** **GHz/dB(m)**

---

## See also

To obtain flatness corrected power refer to the chapter entitled “Creating User Flatness Correction Arrays,” later in this manual.



---

# Leveling with a power meter

Leveling with a power meter is similar to leveling with a diode detector.

1. Set up the equipment as shown in Figure 2-3. Be sure to set the power meter to the correct manual range mode for the output power setting at which you are leveling.

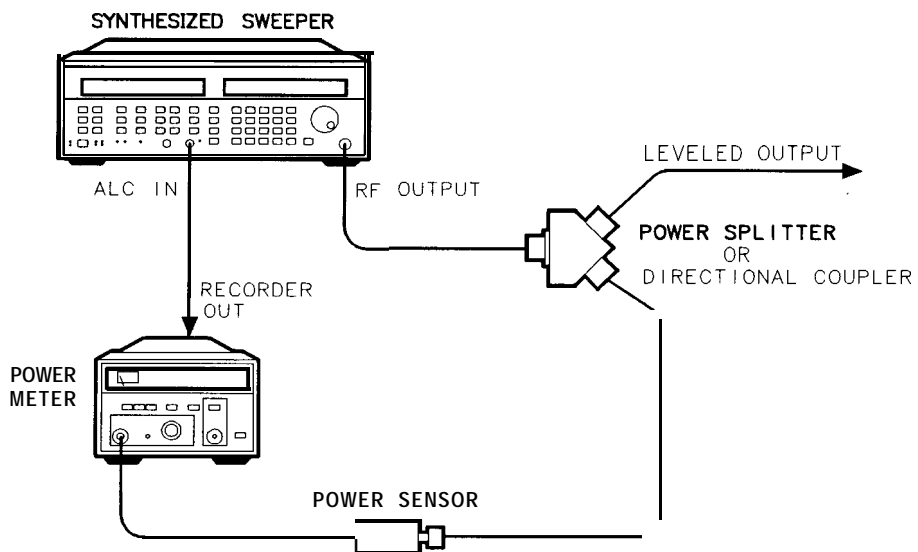

pg418ab

Figure 2-3. leveling with a Power Meter

2. Press **ALC MODE** repeatedly until the MARKER/SWEEP/STATUS display shows **ALC=Power Meter**. Note that the EXT ALC annunciator is lit.
3. Select **SHIFT** **EXT CAL** **0** **GHz/dB(m)**. (If a directional coupler is used, enter the coupling factor of the coupler.)

**NOTE**

The coupling factor is defined by the equation  
**leveled power (P lev) – detected power (P det)**. Refer to Figure 2-1 for locations of P lev and P det. After the coupling factor has been entered, the front panel knob may be used to fine tune the displayed power to equal the actual leveled output power (P lev).

4. If the power meter and the sweeper power setting don't agree, set the coupling factor step size to 10 dB and then use the  $\uparrow$   $\downarrow$  keys to adjust the coupling factor up or down until the power meter and the sweeper power setting agree.
5. Select the sweep tune by pressing **TIME** and then entering the desired sweep rate.

**NOTE**

Due to the settling time required by power meters, it is recommended to use a 40 second sweep rate.

Unlike detector leveling, power meter leveling provides calibrated power out of the leveled RF port.

---

## See also

To obtain flatness corrected power refer to “Creating User Flatness Correction Arrays, ” later in this manual.

---

# Leveling with millimeter-wave source modules (option 1EE only)

Millimeter-wave source module leveling is similar to power meter leveling, except that a slow sweep time is not required. Figure 2-4 and Figure 2-5 illustrate the setups for leveling with a mm-wave source module.

Figure 2-4 illustrates the setup that is used with the HP 83751B and HP 83752B (high power models). No external amplifier is required to obtain maximum specified power. The interface extender cable (HP part number 5062-7202) allows the source module to be positioned in front of the sweeper.

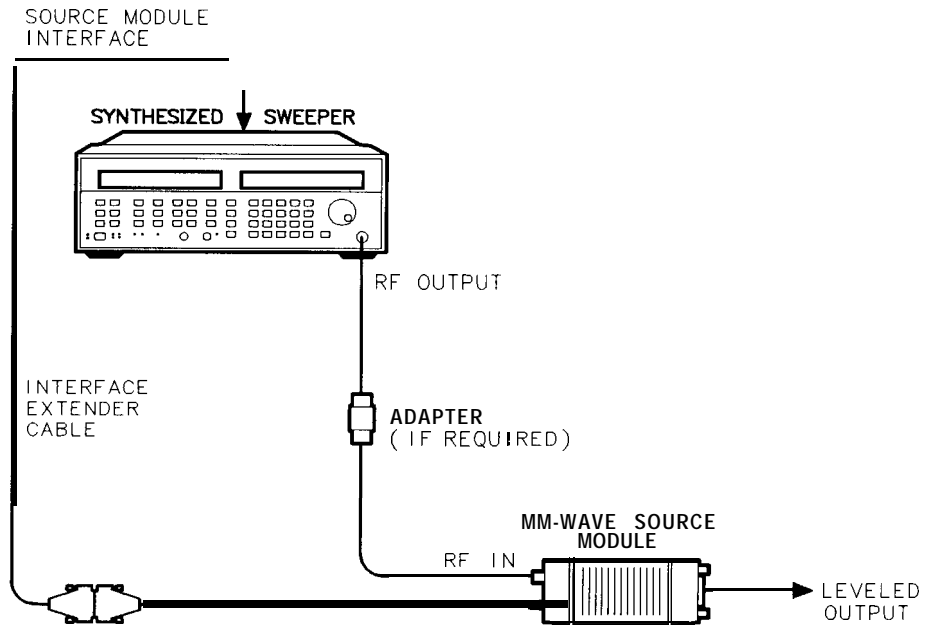

pg420ab

Figure 2-4. Millimeter-wave Source Module leveling

Figure 2-5 illustrates the setup that is used with the HP 83751A and HP 83752A (standard power models). An external amplifier is required to obtain maximum specified power.

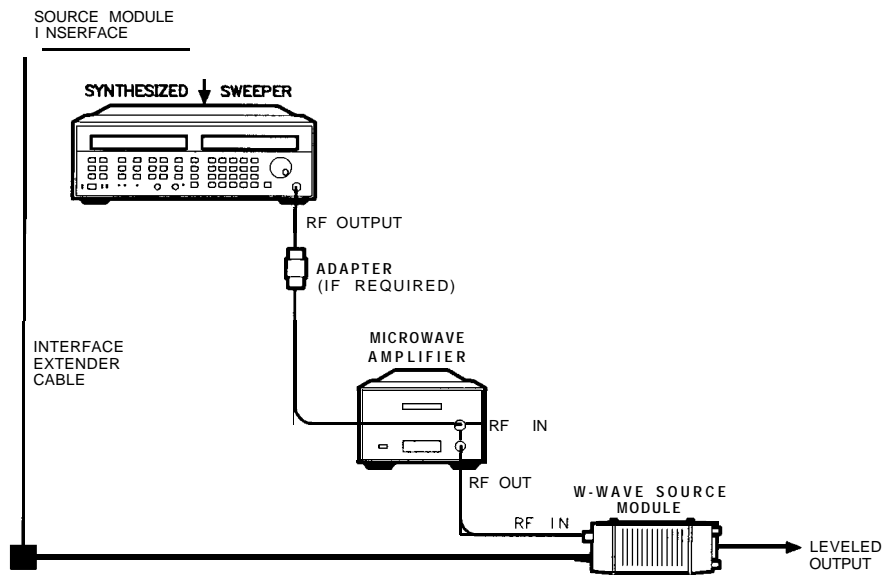

pg421ob

Figure 2-5. Millimeter-wave Source Module leveling Using a Microwave Amplifier

1. Turn the sweeper line power off.
2. Set up the equipment as shown in Figure 2-4 or Figure 2-5.
3. Turn the sweeper line power on and press **PRESET**.
4. When the **PRESET** key is pressed, the sweeper configures itself for source module operation, and all of the ALC data necessary to communicate properly with the sweeper is exchanged via the rear panel **SOURCE MODULE INTERFACE**. Note that the **EXT ALC** annunciator is lit, and that the **POWER** display shows the millimeter head output power.

---

## See also

To obtain flatness corrected power refer to “Creating User Flatness Correction Arrays, ” later in this manual.

---

## Generating a Stepped Sweep

---

# Generating a Stepped Sweep

To generate a stepped sweep, perform the following steps:

1. Press (PRESET).
2. Select the desired (START) and (STOP) frequencies.
3. Select the desired number of points by pressing (SHIFT) POINTS and entering the desired number.
4. Press (SHIFT) SWEEP MODE  $\updownarrow$ .
5. Press the (⇧) key. The MARKER/SWEEP/STATUS display should read Sweep=Step Cont and the STEP annunciator should be lit.
6. The instrument is now running in stepped sweep mode.

## NOTE

The stepped sweep time is calculated by the following formula:

**Stepped Sweep Time = Dwell Time \* Number of Points.** Therefore the stepped sweep time can be changed in one of two ways:

- By changing the dwell time. (Press (TIME) while in stepped sweep mode.)
- By changing the number of points. (Press (SHIFT) POINTS .)

---

## Generating a Millimeter Signal



---

# Generating a Millimeter Signal

If your sweeper was ordered with Option 1EE, you have the capability of using HP 83550 series millimeter head source modules with the sweeper. The interface extender cable (HP part number 5062-7202) that is provided with all option 1EE sweepers allows the source module to be positioned in front of the sweeper.

After a source module is connected to the sweeper via the SOURCE MODULE INTERFACE connector, the sweep will automatically configure itself for source module operation when the line power is cycled, when the sweeper is preset, or when a register is recalled.

---

## Using millimeter heads with “B” model (high power) sweepers

Figure 4-1 shows the equipment setup for using a millimeter head with your HP 83751B or HP 83752B.

1. Turn the sweeper line power off, and connect the equipment as shown in Figure 4-1.
2. Turn the sweeper on, and press **PRESET**.
3. The sweeper automatically configures itself for source module operation when the **PRESET** key is pressed.

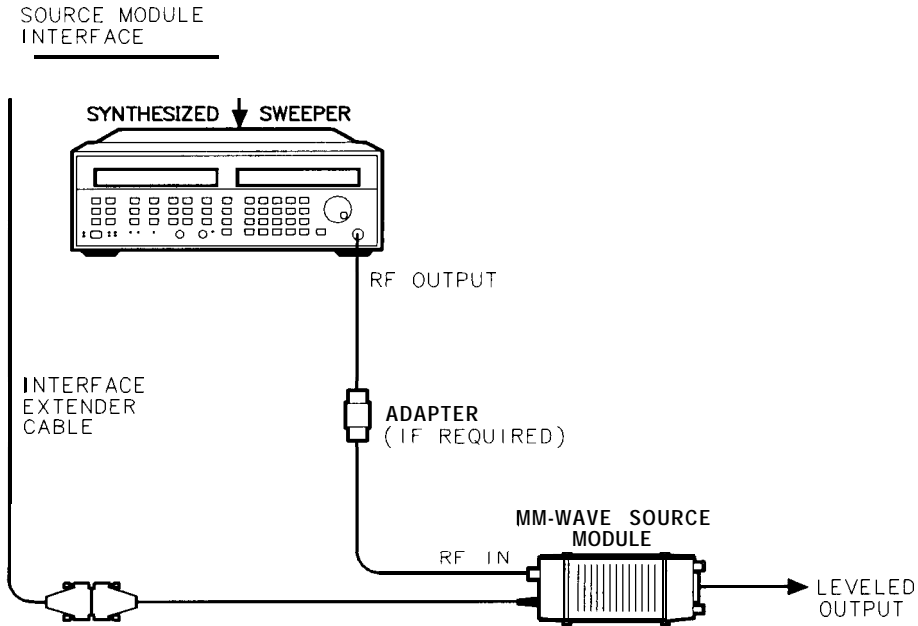

pg420ab

Figure 4-1. Millimeter-wave Source Module leveling

---

## Using millimeter heads with “A” model (standard power) sweepers

Figure 4-2 shows the equipment setup for using a millimeter head with your HP 83751A or HP 83752A. An external amplifier is required to obtain maximum specified power.

1. Turn the sweeper line power off, connect the equipment as shown in Figure 4-1.
2. Turn the sweeper on, and press **PRESET**.
3. The sweeper automatically configures itself for source module operation when the (PRESET) key is pressed.

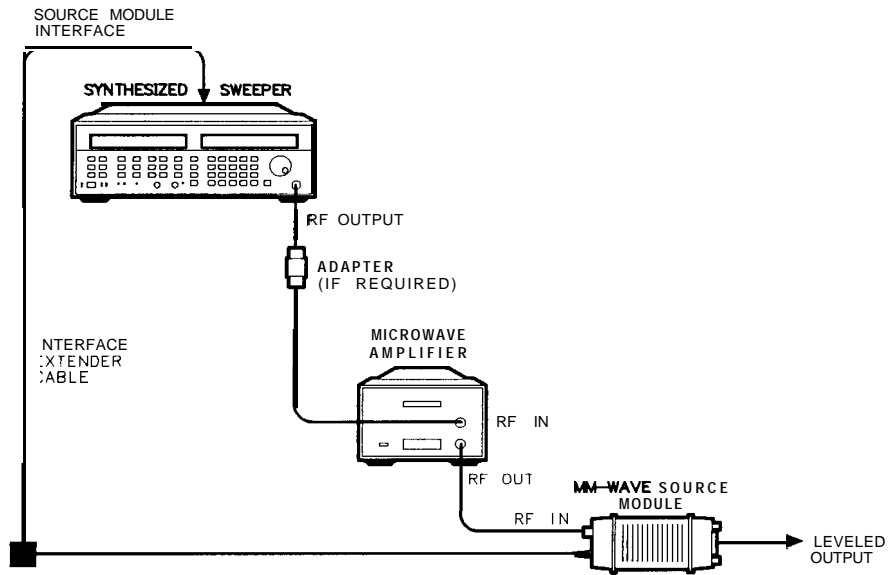

pg421ab

Figure 4-2. Millimeter-wave Source Module leveling Using a Microwave Amplifier

---

## See also

To obtain flatness corrected power refer to “Creating User Flatness Correction Arrays,” later in this section.

---

Creating User Flatness  
Arrays

---

# Creating User Flatness Arrays

This chapter explains how to create user flatness correction arrays, which calibrate the power level at a remote test port. Two examples are provided:

- The first example shows the basic setup and steps to create a user flatness array.
- The second example shows how to set up a scalar analysis measurement using a user flatness correction array.

---

## Creating a user flatness array

In this example an HP 437B power meter controlled by the sweeper through the interface bus (HP-IB) is used to enter the correction data into a flatness array.

Figure 5-1 shows a typical system setup. The setup shown assumes that if the setup has an external leveling configuration, that the steps necessary to correctly level have been taken. Refer to Chapter 2, "Externally Leveling the Sweeper," for information on external leveling.

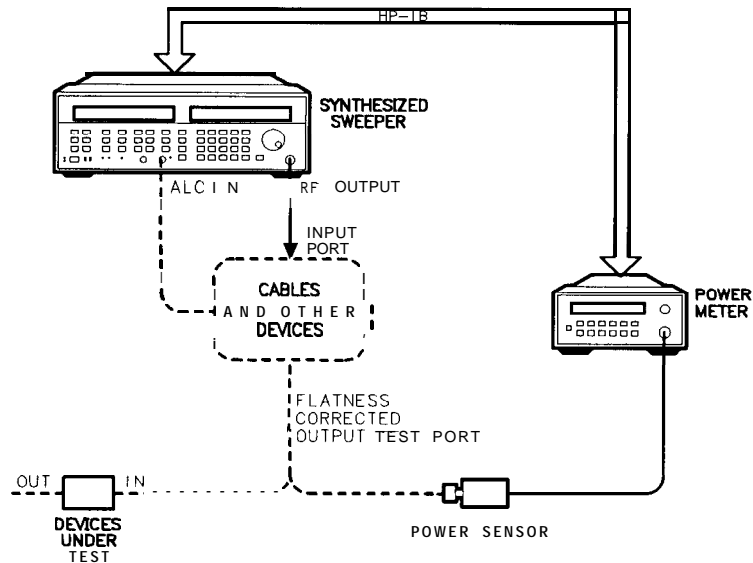

pg422ab

Figure 5-1. Creating a User Flatness Array



## To set up the sweeper

1. Connect the equipment as shown in Figure 5-1. Do not connect the power sensor to the system yet. Press **PRESET** on the sweeper.
2. If a frequency range other than the full range of the instrument is desired, use the **START** and **STOP** keys to input the desired frequency range.
3. If external cables and/or devices are used between the sweeper leveling point (the RF OUTPUT if internally leveled, or the coupler/splitter output if externally leveled) and the remote test port, the nominal (average) loss of these components should be entered as an offset. To enter the power offset, press **SHIFT** OFFSET (in the POWER key group) and then enter the nominal loss from the leveling point of the sweeper to the test port. (For example, if there is a 6 dB loss from the leveling point to the remote test port, enter a power offset of +6 dB.)
4. Set the power level to the level desired *at the test port* by pressing, **POWER LEVEL** and entering the desired number.
5. Select **SHIFT** SPECIAL **12** **Hz/s/ENTER**. Use the **↑** **↓** keys to select the type of power meter you will be using. (437B for this example.)
6. Select **(SHIFT) SPECIAL 13** **Hz/s/ENTER**. Enter the HP-IB address of the power meter you will be using for the calibration. (Thirteen is the default address for power meters.)
7. Press **SHIFT** FLTNESS CAL
  - a. Select whether to calibrate over **Star-Stop** (correction points will be linearly spaced over the selected Start/Stop frequency range, or **FULL BAND** (correction points will be linearly spaced over the full frequency range of the instrument). Use the **↑** **↓** keys to make your selection, then press **Hz/s/ENTER**.
  - b. Select the number of correction points, using the keypad for your entry (valid entries range from 2 to 801), then press **Hz/s/ENTER**.
  - c. The MARKER/SWEEP/STATUS display should now read:  
Connect 437BPM - - ENTER.

---

## To set up the power meter

- Zero and calibrate the power meter/sensor.
- Enter the appropriate power sensor calibration factors into the power meter.
- Enable the power meter/sensor cal factor array. For operating information on the HP 437B power meter refer to its operating and service manual.
- Connect the power sensor to the point where corrected power is desired. (See Figure 5- 1.)

---

## To start the user flatness cal

- The MARKER/SWEEP/STATUS display should still read:  
Connect 437B P M - - ENTER .
- Press **Hz/s/ENTER** to start the calibration. The display will show each correction point's frequency and power as it is measured.
- When the calibration is finished, the flatness correction is automatically turned on, and the FLTNESS ON LED annunciator is lit on the front panel of the sweeper. Power correction will be linearly interpolated between the measured correction points. The POWER display will now show the test port power.

### Attention!

Before doing anything else, save this calibration in one of the instrument's registers. If the calibration has not been saved, and the instrument is preset, a register is recalled, or the power offset is changed, the calibration will be lost. To save the calibration, press **SAVE** and then enter the number of the instrument register you wish to save it in.

# Creating a user flatness array for use in a scalar analysis measurement

The following example demonstrates how to setup a scalar analysis measurement (using an HP 8757 Scalar Network Analyzer) of a test device, such as an amplifier. User flatness correction is used to compensate for power variations at the test port of a directional bridge.

In this example an HP 437B power meter controlled by the sweeper through the interface bus (HP-IB) is used to enter the correction data into a flatness array.

Figure 5-2 shows a typical system setup. The setup shown assumes that if the setup has an external leveling configuration, that the steps necessary to correctly level have been taken. Refer to Chapter 2, "Externally Leveling the Sweeper," for information on external leveling.

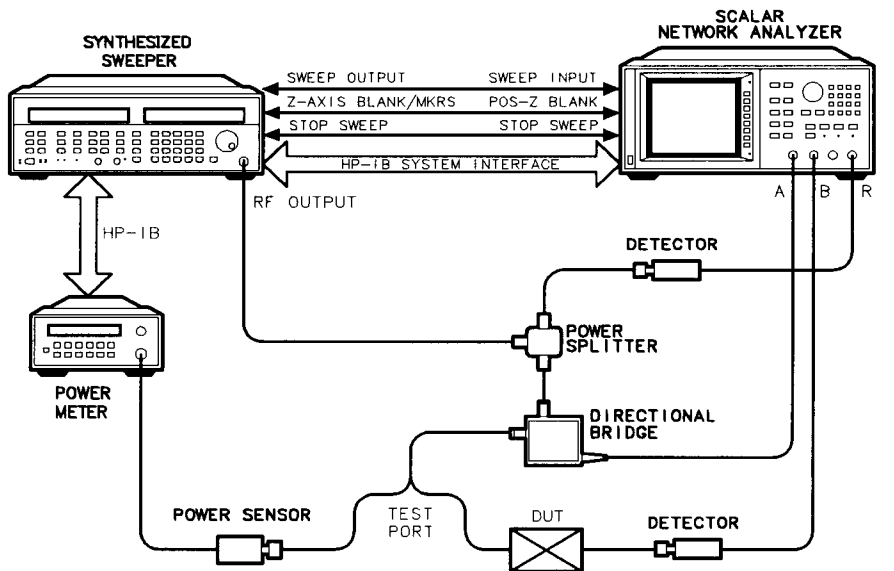

pg423ob

**Figure 5-2. Scalar Measurement System Setup**

---

## To set up the sweeper

1. Connect equipment as shown in Figure 5-2. Do not connect the power sensor to the system yet.
2. Press (**PRESET**) on the scalar analyzer (HP 8757).
3. If a frequency range other than the full range of the instrument is desired, use the (**START**) and (**STOP**) keys on the sweeper to input the desired frequency range.
4. If external cables and/or devices are used between the sweeper leveling point (the RF OUTPUT if internally leveled, or the coupler/splitter output if externally leveled) and the remote test port, the nominal (average) loss of these components should be entered as an offset. To enter the power offset, press (**SHIFT**) **OFFSET** (in the **POWER** key group) and then enter the nominal loss from the leveling point of the sweeper to the test port. (For example, if there is a 6 dB loss from the leveling point to the remote test port, enter a power offset of +6 dB.)
5. Set the power level to the level desired at *the test port* by pressing (**POWER LEVEL**) and entering the desired number.
6. Select (**SHIFT**) **SPECIAL** (12) (**Hz/s/ENTER**). Use the (**↑**) (**↓**) keys to select the type of power meter you will be using. (437B for this example.)
7. Select (**SHIFT**) **SPECIAL** (**13**) (**Hz/s/ENTER\_**). Enter the HP-IB address of the power meter you will be using for the calibration. (Thirteen is the default address for power meters.)

---

## To set up the analyzer

1. On the analyzer, set up the appropriate measurement (i.e. gain for an amplifier). Calibrate the measurement (thru and short/open calibration). Press (**SAVE**) (**1**) on the analyzer to store the analyzer configuration and sweeper parameters in storage register 1.

---

**Attention!**

Do not proceed until the HP 8757 system interface is turned off by pressing **SYSTEM**. Then by pressing softkeys, MORE, **SWEEP MODE**, and **SYSINTF ON OFF** on the analyzer.

---

## To set up the power meter

1. Zero and calibrate the power meter/sensor.
2. Enter the appropriate power sensor calibration factors into the power meter.
3. Enable the power meter/sensor cal factor array. For operating information on the HP 437B power meter refer to its operating and service manual.
4. Connect the power sensor to the point where corrected power is desired. (See Figure 5-2.)

---

## To start the user flatness cal

1. On the sweeper, press **SHIFT** **FLATNESS CAL**
  - a. Select whether to calibrate over **StarStop** (correction points will be linearly spaced over the selected Start/Stop frequency range, or **FULL BAND** (correction points will be linearly spaced over the full frequency range of the instrument). Use the **↑** **↓** keys to make your selection, then press **Hz/s/ENTER**.

- b. Select the number of correction points, using the keypad for your entry. Valid entries range from 2 to 801, then press **Hz/s/ENTER**.
  - c. The MARKER/SWEEP/STATUS display should now read:  
Connect 437B P M - - ENTER.
2. Press **Hz/s/ENTER** to start the calibration. The display will show each correction point's frequency and power as it is measured.
  3. When the calibration is finished, the flatness correction is automatically turned on, and the FLTNESS ON LED annunciator is lit on the front panel of the sweeper. Power correction will be linearly interpolated between the measured correction points.
  4. Save the calibration by pressing **SAVE** **1** on the sweeper.

**Attention!**

If the calibration is not saved in an instrument register, and the sweeper or analyzer is preset, a register is recalled, or the power offset is changed, the calibration will be lost. Reactivating the SYSINTF on the analyzer will also cause a preset and loss of the calibration. Be sure to save the calibration as described in the previous step before continuing.

---

## To reactivate the HP 8757 system interface

1. Press the softkey SYSINTF **ON** OFF on the analyzer and the sweeper will preset.
2. Press **RECALL** **1** to pull up the calibration.
3. Devices can now be tested.

---

Operating a Master/Slave  
Setup

---

# Operating a Master/Slave Setup

Two HP 83750 series sweepers can be configured for two-tone measurement capabilities. Two synchronously tracking sweepers can be configured as a “master/slave” pair for mixer characterization or inter-modulation distortion measurements. The swept frequency accuracy allows control of the sweepers at Exed- or swept-frequency offsets.

To implement master/slave operation, configure the sweepers as shown in Figure 6-1. The master sweeper generates the 10 MHz frequency reference for both sources. The source synchronization cable (HP part no. 83750-60059) must be connected between the auxiliary interface connectors on the rear panels of the sweepers.

When configuring a two-tone measurement system, the slave does not need to interface with any instruments other than the master. The master should interface with the display device (scalar analyzer or oscilloscope, for example) as if it were a stand-alone sweeper.



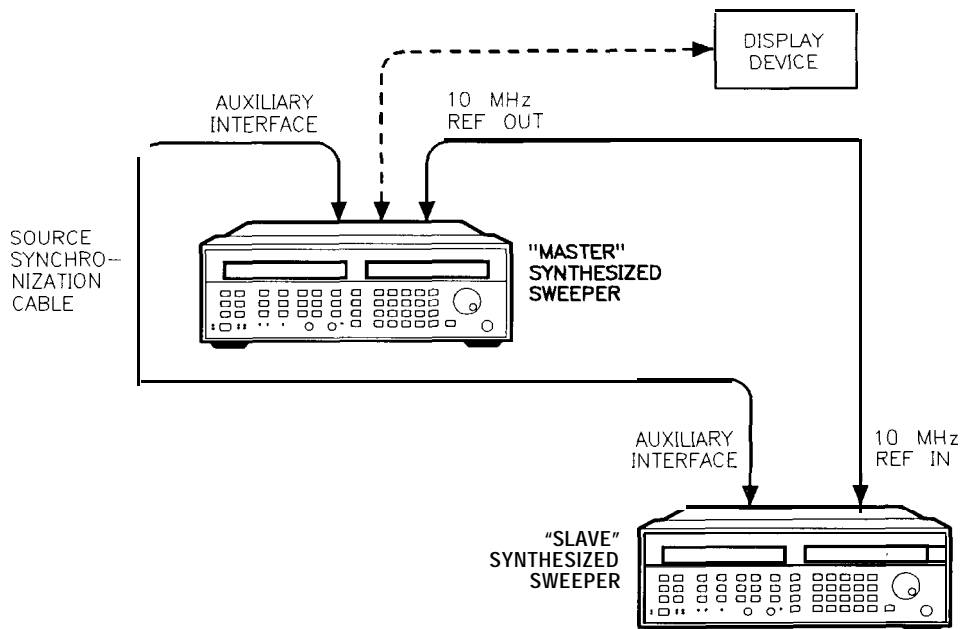

pg424 ab

Figure 6-1. Master/Slave Setup

---

## To set up the master sweeper

1. Press **PRESET**.
2. Activate the master mode by pressing **SHIFT**, **(SPECIAL)**, **19**, **Hz/s/ENTER**.  
If the display does *not* read **CtrlMode=MASTER**, then press the **↑** key once to set the control mode to master.
3. Set the desired frequencies by using the **START**/**STOP** keys, the **CF**/**SPAN** keys, or the **CW** key.

### NOTE

It is recommended that the master and slave sweepers frequencies not differ more than 5 GHz at any point in the sweep. If this requirement is not met, it is possible for unlocks to occur. If frequency offsets greater than 5 GHz are required, it may be necessary to reduce the sweep speeds to eliminate unlocks.

4. Set the desired power level using the **(POWER LEVEL)** key.

### **For swept measurements.**

5. Set the desired sweep time using the **(TIME)** key. (The recommended minimum sweep time for master/slave mode is 100 ms.)

### NOTE

The master and slave sweepers must have identical sweep times. Therefore, the value entered here must also be entered into the slave sweeper.

**For stepped measurements.**

6. Set the sweep mode to stepped by pressing **(SHIFT)** SWEEP MODE  $\updownarrow$ , and then pressing the **(↑)** key until the display reads: Sweep=Step Cont.
7. Set the number of points by pressing **(SHIFT)** POINTS and entering the desired number of points.

**NOTE**

The master and slave sweepers must have identical sweep mode, number of points, and sweep time settings. Therefore, the values entered here must also be entered into the slave sweeper.

---

## To set up the slave sweeper

1. Press **(PRESET)**.
2. Activate the slave mode by pressing **(SHIFT) (SPECIAL) (19) (Hz/s/ENTER)**.  
Press the **(↑)** key until the display reads **Cntr 1 Mode=SLAVE**.
3. Set the desired frequencies by using the **(START) (STOP)** keys, the **(CF) (SPAN)** keys, or the **(CW)** key.

### NOTE

It is recommended that the master and slave sweepers frequencies not differ more than 5 GHz at any point in the sweep. If this requirement is not met, it is possible for unlocks to occur. If frequency offsets greater than 5 GHz are required, it may be necessary to reduce the sweep speeds to eliminate unlocks.

4. Set the desired power level using the **(POWER LEVEL)** key.

### For swept measurements.

5. Set the sweep time to the same value as the master sweeper using the **(TIME)** key. (The recommended minimum sweep time for master/slave mode is 100 ms.)

### For stepped measurements.

6. Set the sweep mode to stepped by pressing **(SHIFT) SWEEP MODE (↓)**, and then pressing the **(↑)** key until the display reads: **Sweep=Step Cont.**
7. Set the number of points to the same value as the master sweeper by pressing **(SHIFT) POINTS** and entering the number of points.

---

## See also

For a pinout description of the source synchronization cable, see the “Multi-pin Connectors” section of Chapter 7, “Front/Rear Panel.”



Front/Rear Panel

---

# Front/Rear Panel

This chapter contains detailed information on various aspects of the sweeper front and rear panel. Information on the following can be found in this chapter:

- Connectors
- Display
- HP-IB Lang/Address Switch
- Knob
- Line Power Switch
- Power Cables

# Connectors

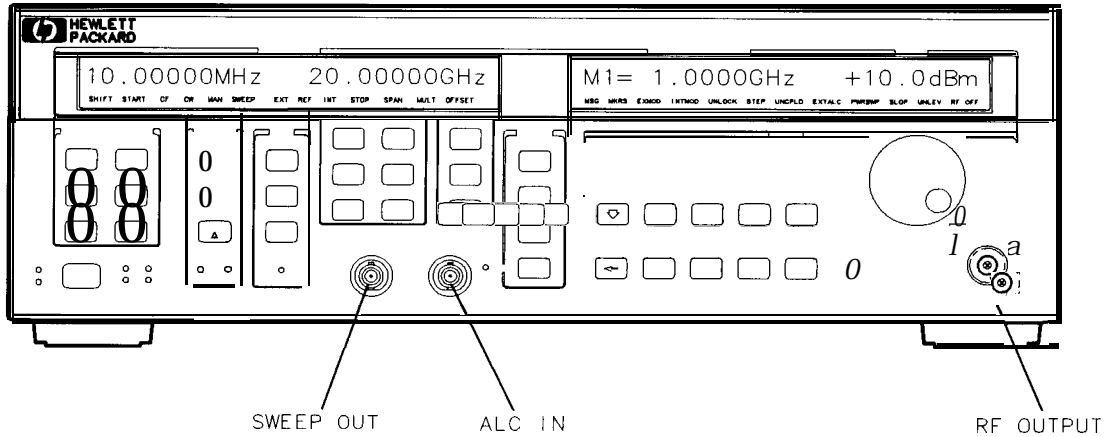

pg412ab

Figure 7-1. Sweeper Connectors - Front Panel



Connectors

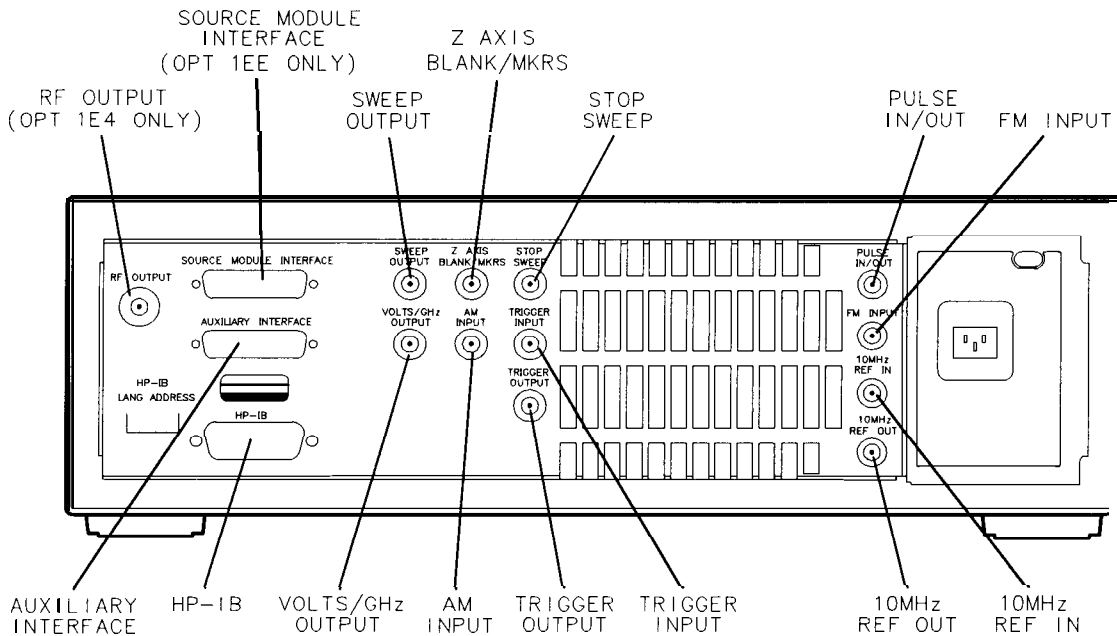

pg413ab

Figure 7-2. Sweeper Connectors - Rear Panel

---

## BNC Connectors

10 MHz REF IN	This rear panel female BNC connector accepts a -5 to + 10 dBm signal from an external time base reference which is within $\pm 10$ ppm of 10 MHz or any sub-multiple down to 1 MHz. The nominal input impedance is $50 \Omega$ . This connector detects when a valid reference signal is connected to it and automatically switches from internal to external reference operation.
10 MHz REF OUT	This rear panel female BNC connector provides a nominal signal level of 0 dBm, and output impedance of $50 \Omega$ . The accuracy is determined by the tune base used.
ALC IN	This front panel female BNC connector is used for external power meter leveling or external negative detector leveling. The damage level is $\pm 15$ V. The nominal input impedance is $100 \text{ k}\Omega$ .
AM INPUT	This rear panel female BNC connector accepts the amplitude modulating signal input when External AM is enabled. The nominal input impedance is $3.5 \text{ k}\Omega$ . The damage level is $\pm 15$ v.
FM INPUT	This rear panel female BNC connector accepts the frequency modulating signal input when DC or AC FM is enabled. The nominal input impedance is $1 \text{ k}\Omega$ . The damage level is $\pm 15$ v.
PULSE IN/OUT	<p>This rear panel female BNC connector can be used as either an external pulse input or output for internal pulse modulation. In either case, it is TTL level compatible and has a nominal impedance of <math>5 \text{ k}\Omega</math>. The damage level is <math>\geq +10</math> V or <math>\leq -5</math> V.</p> <p>A TTL high level (<math>&gt; +2</math> V) enables the selected power level to be at the RF OUTPUT connector, while a TTL low level turns the RF off.</p>

## Connectors

STOP SWEEP	This rear panel female BNC connector causes a sweep to be stopped when this input is pulled low. Retrace does not occur, and the sweep resumes when this input is pulled high. The open circuit voltage is TTL high and is internally pulled low when the instrument stops its sweep. The damage level is $\geq +10\text{ V}$ or $\leq -4\text{ V}$ .
SWEEP OUT	<p>These front and rear panel female BNC connectors provide a voltage range of 0 to +10 V. When the instrument is sweeping, the SWEEP OUT ranges from 0 V at the beginning of the sweep and +10 V at the end of the sweep regardless of the sweep width. In CW mode, the SWEEP OUT ranges from 0 V at the sweeper minimum frequency to +10 V at the specified maximum frequency, with a proportional voltage for frequencies between the specified minimum and maximum. When the sweeper is in manual sweep operation, the SWEEP OUT voltage is a percentage of the span. The nominal output impedance is 100 <math>\Omega</math>. The typical accuracy is <math>\pm 0.05\%</math>, <math>\pm 5\text{ mV}</math> into a high impedance load.</p> <p>When used with the HP 8757D scalar analyzer in ramp-sweep mode, the rear panel output is a series of 0 to +10 V pulses similar to the Trigger Output.</p>
TRIGGER INPUT	This rear panel female BNC input is activated on a TTL rising edge. It is used to externally initiate an analog sweep or to advance to the next point in stepped sweep mode. The damage level is $\geq +10\text{ V}$ or $\leq -4\text{ V}$ .
TRIGGER OUTPUT	This rear panel female BNC connector outputs a 1 $\mu\text{s}$ wide negative-going TTL pulse at 1601 points evenly spaced across an analog sweep, or at each point in stepped sweep mode. When used with the HP 8757D scalar analyzers, the number of pulses per sweep (in analog sweep mode) is determined by the number of HP 8757 trace points.
VOLTS/GHz OUTPUT	This rear panel female BNC connector supplies a voltage that is proportional to the RF output frequency, which can be configured to any desired sensitivity and offset within a $\pm 12\text{ V}$ range. The default setting is 0.5 V/GHz. The minimum load impedance is 2 k $\Omega$ . The typical accuracy is $\pm 0.1\% \pm 10\text{ mV}$ .

Z AXIS  
BLANK/MKRS

This rear panel female BNC connector supplies a positive rectangular pulse (approximately +5 V into 2 k $\Omega$ ) during the retrace and band switch of the RF output when the instrument is sweeping. This output also supplies a -5 V pulse when the RF output is coincident with a marker frequency.

---

## Multi-pin Connectors

### AUXILIARY INTERFACE

This connector provides special control signals used in master/slave interface operation with another source, and in other special-purpose applications. This connector is a 25-pin D-subminiature receptacle located on the rear panel.

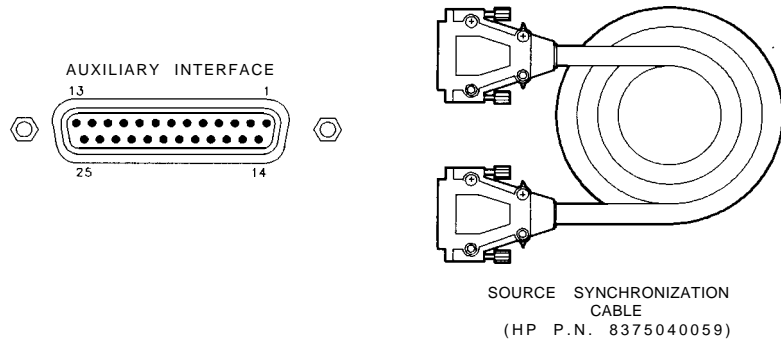

pg414ab

Figure 7-3. Auxiliary Interface Connector

Table 7-1. Pin Description of the Auxiliary Interface

Pin #	Function	In/Out	Signal level
1	Alternate Sweep Out	out	TTL
2	Z-Axis Blanking/Markers	out	Blank- +5 V Marker- -5 V
3	Spare	In	$\pm 12$ v
4	Rear Panel Control 3	I/O	TTL
5	low Stop Sweep	I/O	TTL
6	+5.2 v	out	+5.2 v
7	Digital Ground		Gnd
8	Low Divider-Sync	I/O	TTL
9	External Trigger	In	TTL
10	Rear Panel Control 1	I/O	TTL
11	Rear Panel Control 0	I/O	TTL
12	Low Retrace	I/O	TTL
13	Alternate Sweep In	In	TTL
14	Low Marker	out	TTL
15	Low Qualified Stop Sweep	out	TTL
16	Rear Panel Control 4	out	TTL
17	Rear Panel Control 2	I/O	TTL
18	Sweep Output	out	0 to 10 V ramp*
19	Digital Ground		Gnd
20	No Connection		
21	No Connection		
22	No Connection		
23	low Source Settled	In	TTL
24	low Source Settled	out	TTL
25	Spare	out	$\pm 12$ v

\* Or 0 to 10 V pulses when used with a HP 87570 scalar analyzer.

Connectors

HP-II

This connector allows the sweeper to be connected to other instruments or devices on the interface bus. Details of this cable are shown in Figure 7-4. HP part numbers for various HP-IB cables that are available are shown in the table following the figure.

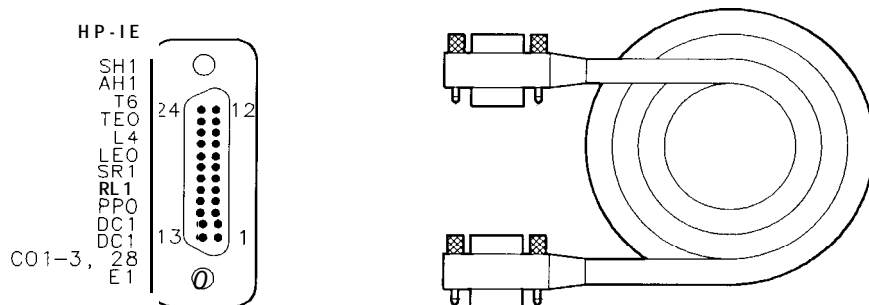

pg415ab

Figure 7-4. HP-IB Connector and Cable

HP-IB Interface Cables Available

HP-IB Cable Part Number	Length
HP 10833A	1 m (3.3 ft)
HP 10833B	2 m (6.6 ft)
HP 10833C	4 m (13.2 ft)
HP 10833D	0.5 m (1.6 ft)

As many as 14 HP-B instruments can be connected to the sweeper (15 total instruments in the system). The cables can be interconnected in a star pattern (one central instrument with the HP-IB cables emanating from that instrument like spokes on a wheel), or in a linear pattern (like boxcars on a train), or a combination of the two. There are certain restrictions that must be followed when interconnecting instruments:

- Each instrument must have a unique HP-IB address, ranging from 0 to 30 (decimal). Refer to “HP-IB Lang/Address Switch” later in this chapter, or “ADDRESS ” in the “Instrument State Keys” chapter for information on setting the sweeper HP-IB address.
- In a two-instrument system that uses just one HP-IB cable, the cable length must not exceed 4 meters (13.2 ft).
- When more than two instruments are connected on the bus, the cable length to each instrument must not exceed two meters (6.6 ft).
- The total cable length between all instruments must not exceed 20 meters (65 ft).

Hewlett-Packard manufactures HP-IB extender instruments (Models HP 37201A and HP 37204A/B) that overcome the range limitations imposed by the cabling rules. These extenders allow twin pair cable operation up to 1 km (3,280 ft), and telephone modem operation over any distance. HP sales and service offices can provide additional information on the HP-IB extenders.



**Connectors**

The codes next to the HP-IB connector, illustrated in Figure 7-4, describe the HP-IB electrical capabilities of the synthesizer, using IEEE Std. 488-1978 mnemonics (HP-IB, GP-IB, IEEE-488, and IEC-625 are all electrically equivalent). Briefly, the mnemonics translate as follows:

SH1	Source Handshake, complete capability.
AH1	Acceptor Handshake, complete capability.
T6:	Talker; capable of basic talker, serial poll, and unaddress if MLA.
TE0	Talker, Extended address; no capability.
L4	Listener, capable of basic listener, and unaddress if MTA.
LE0	Listener, Extended address; no capability.
SR1	Service Request, complete capability.
RL1	Remote Local, complete capability.
PP0	Parallel Poll, no capability.
DC1	Device Clear, complete capability.
DT1	Device Trigger, complete capability.
CO, 1, 2, 3, 28	Controller capability options; CO, no capabilities; C1, system controller; C2, send IFC and take charge; C3, send REN; C28, send I. F. messages.
E1	Electrical specification indicating open collector outputs.

These codes are described completely in the IEEE Standard 488 (1978), *IEEE Standard Digital Interface for Programmable Instrumentation* or the identical ANSI Standard MC1. 1.

SOURCE MODULE  
INTERFACE (Option 1EE  
Only)

This connector sends and receives digital and analog signals to and from an HP 83550-Series millimeter-wave source module. With the source module connected, the sweeper assumes the characteristics of the source module.

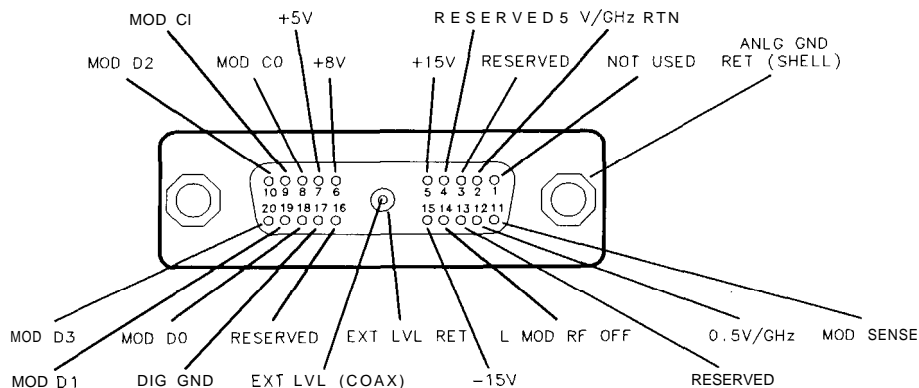

pg416ab

Figure 7-5. Interface Signals of the Source Module Connector

The codes indicated in Figure 7-5 translate as follows:

- MOD D0 Source module data line zero. Signals MOD D0 through MOD D3 are the millimeter source module data bus lines (bidirectional).
- MOD D1 Data line one.
- MOD D2 Data line two.
- MOD D3 Data line three.
- MOD C0 Source module control line zero. Signals MOD C0 and MOD C1 are the control lines for the read/write to and from the millimeter source module.
- MOD C1 Control line one.

## Connectors

MOD SENSE	Source module sense. A 1 mA current is injected on this line by the millimeter source module to indicate its presence. This signal always equals 0 V.
L MOD RF OFF	Low = RF off. Source module RF is turned off.
EXT LVL RET	Source module external leveling return.
EXT LVL	Source module external leveling input, from the millimeter source module.
0.5V/GHz	Internal 0.5V/GHz to the millimeter source module.
-15V	Power supply. Range is -14.25 to -15.45 V. (See note below.)
+15V	Power supply. Range is + 14.25 to + 15.45 V. (See note below.)
+8V	Power supply. Range is +7.50 to +8.45 V. (See note below.)
+5V	Power supply. Range is +4.75 to +5.40 V. (See note below.)

## N O T E

The values for the four power supplies above are valid when a millimeter head is connected. With no load on the connector, the values would be:

- 15 v supply:	-14.4 to -15.45 v
+ 15 v supply:	+ 14.4 v to + 15.45 v
+ 8 v supply:	+ 7.75 v to + 8.45 v
+ 5 v supply:	+ 4.75 v to + 5.40 v

DIG GND	Digital ground.
.5V/GHz RTN	0.5 V/GHz return.
ANLG GND RET	Analog ground return.

---

## RF Output Connector

The standard front panel RF OUTPUT connector is a precision 3.5 mm male connector. When Option 1ED is installed, this front panel connector is a ruggedized Type-N connector. The nominal source impedance is 50  $\Omega$ .

When making connections to this connector, carefully align the center conductor elements, then rotate the knurled barrel while mating components remain still. Tighten the barrel until firm contact is made.

Take care when working with this connector. If the connector is mechanically degraded in any way, high frequency losses can occur. Refer to application note 326, *Coaxial Systems - Principles of Microwave Connector Care* (HP part number 5954-1566) for more information.

---

# Display

The sweeper front panel display contains two areas (Frequency, and Marker/Sweep/Status and Power) for displaying the current operating parameters of the sweeper. Front panel annunciators show the status of several of the sweeper functions and settings.

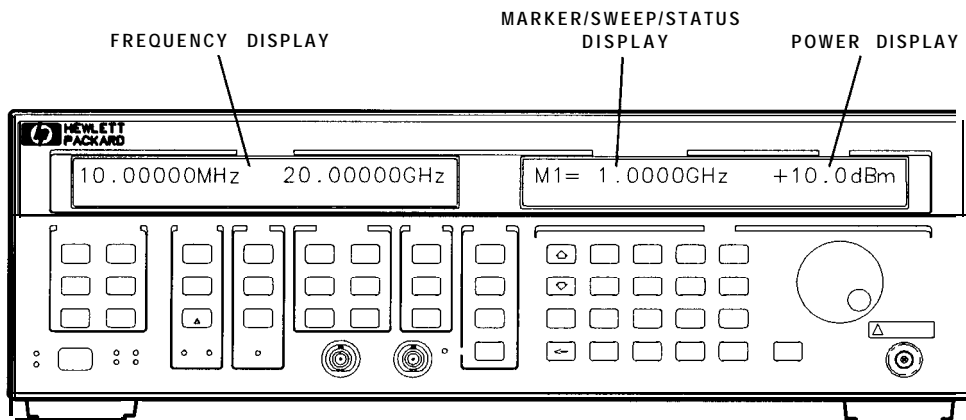

pg410gb

Figure 7-6. Sweeper Display

---

## Frequency Display

The left-hand display is labelled FREQUENCY and is used exclusively to show information about frequencies being generated. (Information about markers is not pertinent to generated frequencies and is not displayed here.)

In Start/Stop and CF/Span sweep modes, the left display has two separate fields of 11 characters each, whose contents depend on the instrument mode. Two blank spaces separate the two fields. Frequencies are displayed using eight significant digits, followed by a three-character frequency unit (kHz, MHz, or GHz). The decimal multiplier is changed automatically to keep the number being displayed in the range of 1 to 999.99999, and digits below 1 kHz resolution are not shown. Leading zeros are suppressed.

In CW mode, there is one 24-character field. Frequencies are displayed using up to 11 significant digits, followed by a three-character frequency unit (kHz, MHz, or GHz). The decimal multiplier is changed automatically to keep the number being displayed in the range of 1 to 999.99999, and digits below 1 Hz resolution are not shown. Leading zeros are suppressed.

### NOTE

The decimal separator (either . or ,) can be changed by selecting Special function number 18. Refer to the "Special Functions" chapter for more information.

---

## Marker/Sweep/Status and Power Display

The right-hand display is divided into two fields, although there is no physical separation between them. (Normally, one blank space is inserted between the left and right Eelds. When some features are accessed, however, all 24 characters of the right display can be used.)

The left Eeld is labelled MARKER/SWEEP/STATUS, and is used to show a variety of information including marker frequencies, sweep time, and general instrument status. Sixteen characters are reserved for this Eeld, including any units displayed.

The right Eeld is labelled POWER, and displays the power level in dBm. It is seven character cells wide. Exed format.

---

### NOTE

When operating the sweeper in a secure environment, the display can be blanked so that the sweeper parameters and status cannot be viewed. For more information, refer to the "Special Functions" chapter of this manual.

## Annunciators

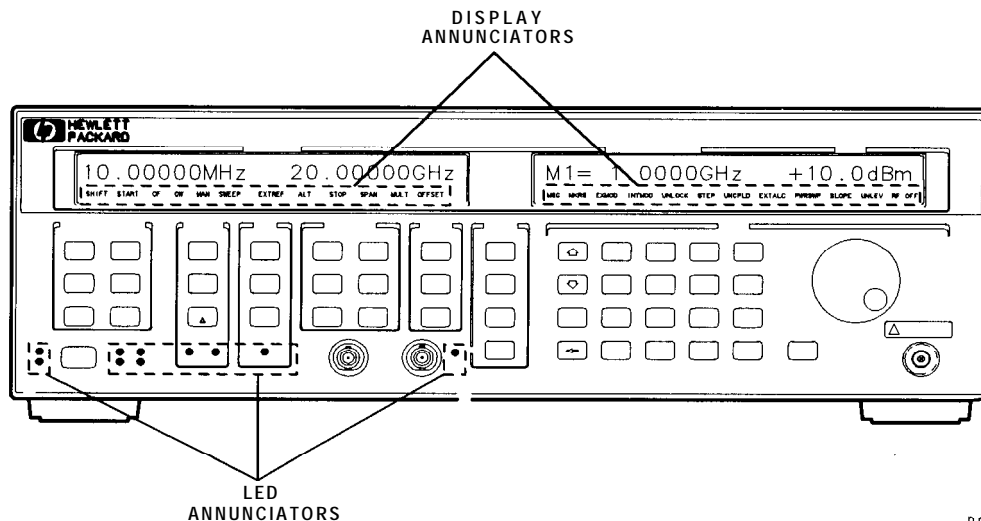

pg411ab

Figure 7-7. Sweeper Display and LED Annunciators

The front panel annunciators show the status of several of the sweeper functions and settings. Refer to Figure 7-7. Notice that there are two types of annunciators: display and LED.

*A display annunciator is not visible if its associated function is not active or selected.* For example, if external pulse modulation is currently selected, the EXTMOD annunciator will be lit, otherwise, it will not be visible.

The display annunciators that will appear in the left-hand (frequency) display are SHIFT, START, CF, CW, MAN, SWEEP, EXT REF, ALT, STOP, SPAN, MULT, and OFFSET. The display annunciators that will appear in the right-hand (marker/sweeper/status and power) display are MSG, MKRS, EXTMOD, INTMOD, UNLOCK, STEP, UNCPLD, EXTALC, PWR SWP, SLOPE, UNLEV, and RF OFF.



**Display**

The front panel LED annunciators (R, L, T, S, MKR A, M1→M2 SWP, UNLOCKED FM, and FLTNESS ON) will be lit to show you that an associated condition exists.

An explanation of each annunciator follows.

## Display

## Annunciators

SHIFT	This annunciator appears when <b>SHIFT</b> is pressed, and goes off when any other key is pressed (or when <b>SHIFT</b> is pressed again).
START	This annunciator appears when <b>START</b> or <b>STOP</b> is pressed, and goes off when <b>CW</b> , <b>CF</b> , or <b>SPAN</b> is pressed.
CF	This annunciator appears when <b>CF</b> or <b>SPAN</b> is pressed, and turns off when <b>CW</b> , <b>START</b> , or <b>STOP</b> is pressed.
c w	This annunciator appears when <b>CW</b> is pressed, and turns off when <b>CF</b> , <b>SPAN</b> , <b>START</b> , or <b>STOP</b> is pressed.
MAN	This annunciator indicates that manual sweep mode has been selected.
SWEEP	This annunciator indicates that the instrument is performing a sweep. This annunciator appears <i>only</i> while the instrument actually sweeps, <i>not</i> while it waits for a trigger signal (even though it is in sweep mode). In continuous sweep mode, the annunciator will blink with slow sweeps, but remain on with fast sweeps.
EXT REF	This annunciator indicates that an external frequency reference is in use.
ALT	This annunciator indicates that the alternate sweep mode is active.
STOP	This annunciator appears when <b>START</b> or <b>STOP</b> is pressed and turns off when <b>CW</b> , <b>CF</b> , or <b>SPAN</b> is pressed.
SPAN	This annunciator appears when <b>CF</b> or <b>SPAN</b> is pressed and turns off when <b>CW</b> , <b>START</b> , or <b>STOP</b> is pressed.
MULT	This annunciator indicates that the displayed frequency is a multiple of the actual RF output frequency.

OFFSET	This annunciator indicates that the displayed frequency is offset from the actual RF output frequency.
MSG	This annunciator indicates that the sweeper has a new message that has not been displayed, such as an error message or instrument failure message. Messages are viewed by pressing the front panel <b>MSG</b> key.
MKRS	This annunciator appears when any of the markers (0 to 9) are on.
EXTMOD	This annunciator appears under any of the following conditions: <ul style="list-style-type: none"><li>• AM Mode = External</li><li>• FM Mode = AC/Locked <i>or</i> DC/Unlocked</li><li>• Pulse Mode = External</li></ul>
INTMOD	This annunciator appears if Pulse Mode is set to Internal, Scalar, or 1 kHz square-wave.
UNLOCK	This annunciator appears when any of the internal synthesizer loops are unlocked.
STEP	This annunciator indicates that the Sweep Mode is set to Stepped Sweep.
UNCPLD	This annunciator indicates that automatic coupling between the attenuator and the ALC reference level is turned off in the Special area. (For Option 1E1 instruments only). This mode is automatically selected whenever the ALC mode is not in internal mode or unleveled mode.
EXT ALC	This annunciator indicates that the ALC mode is set to either Diode or Power meter.
PWR SWP	This annunciator indicates that the Power Sweep function is active.
SLOPE	This annunciator indicates that the Power Slope function is active.
UNLEV	This annunciator indicates that the source is unable to maintain the correct output power level for the current output frequency, or that the ALC is turned off.
RF OFF	This annunciator indicates that the RF output is turned off.

**Display****LED****Annunciators**

R	This LED annunciator is lit when the sweeper is in remote HP-IB operation.
L	This LED annunciator is lit when the sweeper is receiving information or commands over HP-IB.
T	This LED annunciator is lit when the sweeper is transmitting information over HP-IB.
S	This LED annunciator is lit when the sweeper is receiving an SRQ over HP-IB.
MKR A	This LED annunciator is lit if the marker delta mode is on.
M1→M2 SWP	This LED annunciator is lit when <u>(M1→M2 SWEEP)</u> is pressed.
UNLOCKED FM	This LED annunciator is lit if the FM mode is set to DC/Unlocked.
FLTNESS ON	This LED annunciator is lit if a power flatness correction array is enabled.

# HP-IB Lang/Address Switch

The HP-IR switch on the rear panel is used to select the sweeper language and HP-IB address when you apply AC power. These parameters can also be selected via front panel operation.

Refer to Figure 7-8 for a pictorial explanation of the various switch settings for the HP-IB address of the sweeper. The selected address depicted in this figure represents an HP-IR address of 19.

When the HP-IR portion of the switch (switch positions 1 through 5) are all set to 1, any address changes made from the front panel are retained through a power cycle of the instrument. If you want your sweeper to default to a particular address at power up, set the switch to the desired address; you can still make changes from the front panel, but they won't be retained through a power cycle.

Refer to Figure 7-9 for a pictorial explanation of the switch settings for instrument language.

Refer to Figure 7-10 for a pictorial explanation of how to set the switch for clearing the register contents at power on.

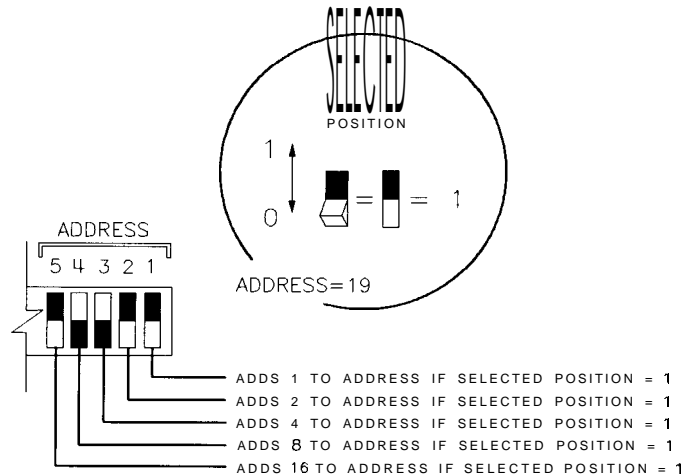

qq425ab

Figure 7-8. HP-IB Address Switch Settings

**HP-IB** Lang/Address Switch

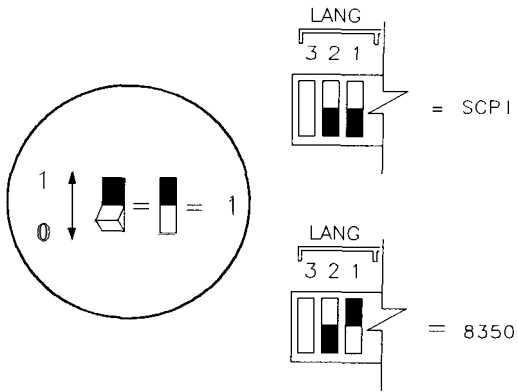

qq426ob

Figure 7-9. Instrument language Switch Settings

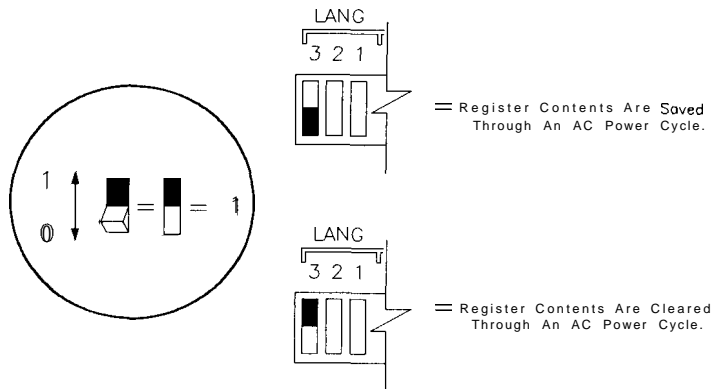

qq423ob

Figure 7-10. Clear Register Contents Settings

---

## See Also

“Instrument  
State Keys”

For information on setting the HP-IB address from the front panel of the sweeper.

“ Special  
Functions”

For information on setting the language from the front panel of the sweeper.

---

# Knob

The front panel knob is used to increase or decrease parameter values. Pointers ( ▼▼▼ ) over a parameter or numeric value in the display indicate that the function is active and its value will be increased or decreased when knob is rotated.

The front panel knob is used to give an analog feel to the setting of the values. Any of the values that can be set through the numeric entry pad, or the step keys, can also be set using the knob. However, the rate at which the active parameter varies, for a given amount of knob rotation, is dependent on the parameter that is being controlled.

If ENTRY OFF ( **SHIFT** **Hz/s/ENTER** ) has been enabled, the pointers will disappear from the display and rotating the knob will have no affect on the sweeper parameters until another function key is pressed.

---

## Equivalent SCPI Commands

The equivalent SCPI commands for knob rotation are SYST : KEY 6 1 which simulates clockwise knob rotation, and SYST:KEY 62 which simulates counterclockwise knob rotation.

---

# Line POWER Switch

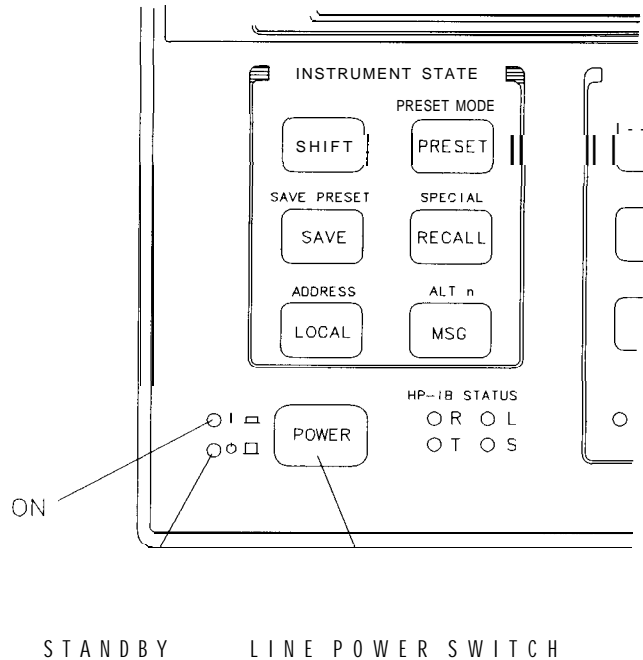

pg49ab

Figure 7-1 1. The Sweeper line POWER Switch

The line POWER switch turns power to the sweeper to either on or standby. The sweeper line POWER switch is located at the bottom left corner of the front panel. Pressing the switch so that the button locks in the “in” position turns the sweeper on and pressing the switch again so that it is in the “out” position turns it to standby. When set to standby, most of the sweeper circuitry is powered off, however, power to the internal timebase (Option 1E5) is not disconnected.

When the sweeper is on, the green LED indicator will be illuminated. When the sweeper is in standby, the amber LED indicator will be illuminated.



---

**WARNING**

Before turning the sweeper on, make sure that it is grounded through the protective conductor of the power cable to a mains power receptacle provided with protective earth contact. Any interruption of the protective grounding conductor inside or outside of the sweeper or disconnection of the protective earth terminal can result in personal injury.

---

---

## Power Cables



The line power cable is supplied in one of several configurations, depending on the destination of the original shipment.

Each instrument is equipped with a three-wire power cable. When connected to an appropriate AC power receptacle, this cable grounds the instrument chassis. The type of power cable shipped with each instrument depends on the country of destination. See Figure 7-12, "Power Cable and Line (Mains) Plug Part Numbers", for the part numbers of these power cables. Cables are available in different lengths and some with right-angle plugs to the instrument. Check with your nearest Hewlett-Packard service center for descriptions and part numbers for these cables.

**NOTE**

There is no line voltage selector switch on the instrument. The line module will automatically switch between 110 and 220 Vac as needed.

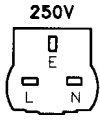
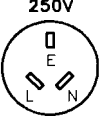
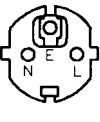
## Front/Rear Panel

PLUG TYPE	CABLE HP PART NUMBER	PLUG DESCRIPTION	CABLE LENGTH CM (INCHES)	CABLE COLOR	FOR USE IN COUNTRY
 <p>250V</p>	8120-1351 8120-1703	Straight* BS1363A 90'	229 (90) 229 (90)	Mint Gray Mint Gray	Great Britain, Cyprus, Nigeria Singapore, Zimbabwe
 <p>250V</p>	8120-1369 8120-0696	Straight* NZSS198/ASC112 90°	201 (79) 221 (87)	Gray Gray	Argentina, Australia, New Zealand, Mainland China
 <p>250V</p>	8120-1689 8120-1692	Straight* CEE7-Y11 90'	201 (79) 201 (79)	Mint Gray Mint Gray	East and West Europe, Central African Republic United Arab Republic (unpolarized in many nations)
 <p>125V</p>	8120-1348 8120-1538 8120-1378 8120-4753 8120-1521 8120-4754	Straight* NEMA5-15P 90° Straight* NEMA5-15P Straight 90° 90'	203 (80) 203 (80) 203 (80) 230 (90) 203 (80) 230 (90)	Block Black Jade Gray Jade Gray Jade Gray Jade Gray	United States Canada, Japan (100 V or 200 V), Brazil, Colombia, Mexico, Philippines, Saudi Arabia, Taiwan
 <p>250V</p>	8120-5182 8120-5181	Straight* NEMA5-15P 90°	200 (78) 200 (78)	Jade Gray Jade Gray	Israel
<p>* Part number for plug is industry identifier for plug only. Number shown for cable is HP Part Number for complete cable, including plug.</p> <p>** E = Earth Ground; L = Line; N = Neutral.</p>					

FORMAT80

Figure 7-12. Power Cable and line (Mains) Plug Part Numbers



## Instrument State Keys

---

# Instrument State Keys

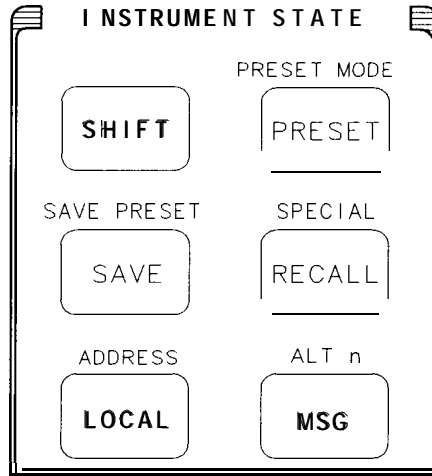

pg42ab

Figure 8-1. Instrument State Group

Registers 1-9 can be used to store instrument states. There is another register used to store the user-defined Preset instrument state.

The current instrument state is also saved continually in another register. All 11 registers are battery-backed-up, and contain the factory-defined preset values until overwritten by other data. When power is turned on, the instrument performs some self-tests and then returns to the last state before power was turned off. The current firmware revision, language mode, and HP-IB address are displayed in the 16-character MARKER/SWEEP/STATUS area; for example, Fw A. 01.00 SCPI 19

---

**SHIFT**

The **SHIFT** key causes the secondary function of any key pressed directly after it to be executed.

When the **SHIFT** key is pressed, the SHIFT annunciator will be visible in the left-hand display. The next key that is pressed after the **SHIFT** key will execute the function that is indicated by the blue text that is above the key. As an example, note that ADDRESS appears in blue text directly above the **LOCAL** key. Viewing and selecting the HP-IB address of the instrument is the secondary function of the **LOCAL** key. Pressing **SHIFT** [LOCAL] will enable the HP-IB address viewing and selecting mode.

If a key with no alternate function is pressed after pressing the **SHIFT** key, the SHIFT annunciator will be canceled from the display and no action will be taken by the instrument.

If you press the **SHIFT** key accidentally, pressing it again will cancel it without altering sweeper operation.

**PRESET**

The **(PRESET)** key sets the sweeper to a known state (either the factory preset condition, or a user-defined preset condition).

The factory preset conditions are shown in the following table. User-defined preset conditions are discussed later in this section, and factory preset conditions for special functions are described in Chapter 15, “Special Functions.”

Table 8-1. Factory Preset Conditions

Parameter	Condition	Parameter	Condition
ALC Mode	Internal	Points	401
Alternate Sweep	Off	Power level	0.0 dBm
AM Mode	Off	Power Offset	0.0 dB
Center Frequency	11 GHz* or 10.005 GHz <sup>†</sup>	Power Sweep	0.0 dB
c w	Center Frequency	Preset Mode	Factory (when shipped)
Dwell Coupling	Off	Pulse Mode	Mod Off
Dwell Time	1 ms	Pulse Period	1.000 ms
External Cal Coup Factor	16.0 dB	Pulse Width	100 s
Flatness Cal Over	Start/Stop	RF On/Off	0n
Flatness On/Off	Off	Single Trigger	Off
FM Mode	Off	Slope	0.00 dB/GHz
Frequency Multiplier	1	Span	18 GHz* or 19.99 GHz <sup>†</sup>
Frequency Offset	0 Hz	Start Frequency	2 GHz* or 10 MHz <sup>†</sup>
HP-IB Address	(rear panel switch) <sup>‡</sup>	Step Size (Freq.)	100 MHz
M1 → M2 Sweep	Off	Step Size (Power)	1 dB
Manual Sweep Mode	Off	Stop Frequency	20 GHz
Manual Sweep Start Freq	Center Frequency	Sweep Mode	Start/Stop Analog
Marker A Mode	Off	Sweep Time	45 ms* of 50 ms <sup>†</sup>
Marker A Ref	1	Swept CW	Off
Marker Frequency	Center Frequency	Trigger Mode	Continuous
Marker Mode	Intensity	User Flatness	Off
Marker Status	All Off		

Associated **SCPI** Commands

**SYSTem:PRESet[:EXECute]** *Returns the instrument to the preset state.*

## Associated 8350 Commands

**IP** *Returns the instrument to the preset state.*

**PRESET MODE** When this function is selected (by pressing **SHIFT** **PRESET**), the current preset mode (factory or user) is shown in the right-hand display of the sweeper. The mode can be changed by pressing the **↑** **↓** keys, or by turning the front panel knob. The preset mode choices are:

- Factory** When **PRESET** is pushed, the instrument is returned to a factory-defined state. (See Table 8-1 in this section.) The right-hand display shows `SysPresType=FACT`.
- User** When **PRESET** is pushed, the instrument is returned to a user-defined state. The right-hand display shows `SysPresType=USER`.

Associated **SCPI** Commands

**SYSTem:PRESet:TYPEFACTory** *Sets the preset mode to "factory."*

**SYSTem:PRESet:TYPE USER** *Sets the preset mode to "user."*



**SAVE**

Pressing the (SAVE) key stores the current instrument state into one of nine registers.

When this key is pressed, the prompt message in the right-hand display of the sweeper is **SAVE Reg = ??**. When a digit  $\langle n \rangle$  is pressed on the entry keyboard, the display becomes **SAVED Reg =  $\langle n \rangle$**  and the instrument state is stored in that register. Note that a unit key (i.e. **Hz/s/ENTER**) does not need to be pushed. Successive numbers can be pushed to store the instrument into multiple registers. Pressing **0** has no effect.

**Associated SCPI Commands**

\* SAV  $\langle n \rangle$

*Saves the instrument state into register  $\langle n \rangle$ .*

**Associated 8350 Commands**

SV  $\langle n \rangle$

*Saves the instrument state into register  $\langle n \rangle$ .*

**SAVE  
PRESET**

When this function is selected (by pressing **(SHIFT) (SAVE)**), the current instrument state is saved into the user-defined preset storage register. The right-hand display shows **Preset. Saved**.

**NOTE**

When the instrument is connected to an HP 8757D scalar network analyzer, its system interface must be temporarily turned OFF in order to save a user-defined preset instrument state. Refer to the *HP 8757D Scalar Network Analyzer Operating Reference*.

**NOTE**

The saved user-defined preset cannot be recalled until User preset is selected using the **PRESET MODE** function, described earlier in this chapter.

**Associated SCPI Commands****SYSTEM:PRESet:SAVE**

*Saves the current instrument state into the userdefined preset storage register.*

**RECALL**

Pressing this key restores the state of the instrument from a register (1-9). When this key is pressed, the prompt message in the right-hand display is **RECALL Reg = ??**. When a digit  $\langle n \rangle$  is pressed on the entry keyboard, the display shows **RECALL Reg =  $\langle n \rangle$**  and the instrument state is recalled from that register. Note that a units key (i.e. **Hz/s/ENTER**) does not need to be pushed. Successive numbers can be pushed to recall instrument state from multiple registers. Entry key **0** has no effect.

**Associated SCPI Commands****\*RCL  $\langle n \rangle$** 



*Restores the state of the instrument from register  $\langle n \rangle$ .*

**Associated 8350 Commands****RC  $\langle n \rangle$** 

*Restores the state of the instrument from register  $\langle n \rangle$ .*

**SPECIAL** When this function is selected (by pressing [**SHIFT**] **RECALL**) the special functions menu is accessed.

When this key is pressed, the last-used special function is displayed in the form  $\langle \text{number} \rangle \langle \text{function} \rangle$ . (If no special functions have been accessed since the instrument was last preset, the last-used special function will default to **1 CWCF AUTO**.) The **↑** **↓** keys or the front panel knob can be used to scroll through the list of available functions in the menu; or the number of the desired special function can be entered from the keypad. When the desired special function is displayed, pressing the **Hz/s/ENTER** key causes the function to become the active parameter displayed in the **MARKER/SWEEP/STATUS** display. Pressing the **←** key returns the last menu item in the form  $\langle \text{number} \rangle \langle \text{function} \rangle$ .

If the special function consists of discrete states (i.e. On/Off or Int/Ext/None), then the   keys or the front panel knob must be used to select the desired state. If the special function is a numerical value, then the keypad may also be used to enter the value.

See Also Chapter 15, “Special Functions”

**LOCAL**

Pressing this key returns the instrument to local (front panel) control ‘from remote operation.

**ADDRESS**

When this function is selected (by pressing **(SHIFT)** **(LOCAL)**), the HP-IB address of the sweeper is displayed in the MARKER/SWEEP/STATUS area in the format `HP-IB Address=xx`, where `xx` represents the two-digit HP-IB address number.

The address can be changed by using the **(↑)** **(↓)** keys, by turning the front panel knob, or by using the entry keypad. The acceptable range of addresses is 0 to 30, with the default value being 19.

**Notes**

1. An HP-IB address entered from the front panel will *not* change when **(PRESET)** is pressed.
2. If the power to the instrument is cycled or lost, the address entered from the front panel will survive *only* if the rear panel HP-IB switch is set to 31; otherwise, after a power cycle or loss, the HP-IB address will default to the rear panel switch setting.

**Associated SCPI Commands**

<code>SYSTEM:COMMunicate:GPIB:ADDRESS</code>	<i>Sets the HP-IB address of the sweeper to &lt;num&gt;</i>
<code>&lt;num&gt;</code>	

See Also “HP-IB Switch” in the chapter titled “Front/Rear Panel” “To Select the Sweeper Language and HP-IB Address” in the *HP 83751A/B and HP 83752A/B Synthesized Sweepers Installation and Quick Start Guide*.

MSG

The **MSG** key causes the last message from the message queue to be displayed in the MARKER/SWEEP/STATUS area of the display.

When a new message appears in the message queue, the MSG annunciator is lit, and remains lit until this key is pressed. If more than one error message is present in the queue, subsequent presses of the **MSG** key will show the next messages in line. When all the messages have been viewed, the queue is cleared, and the MSG annunciator disappears. Typical messages would be regarding instrument failures or errors.

#### Associated SCPI Commands

SYSTem:ERRor?

*Returns the next message in the error queue.*

**ALT n** Choosing this function (by pressing (**SHIFT**) **MSG**) allows you to select one of the instrument states (from registers 1-9) to be alternated with the current instrument state on each successive sweep.

#### NOTE

The alternate sweep function cannot be used with stepped sweep mode.

When this function is selected, the ALT annunciator is turned on, and the prompt message in the MARKER/SWEEP/STATUS display is: HLT SWP Reg=???. At this time, the instrument expects a register to be selected. When a digit is pressed on the entry keyboard, the display becomes HLT SWP Reg=<n>. Note that a Units key (i.e. **Hz/s/ENTER**) does not need to be pushed.

Once a register has been selected, the current instrument state is alternated with the selected state on every successive sweep. The display will only reflect the current instrument state settings, *not* the alternate instrument state settings. Any subsequent parameter changes will affect only the current instrument state, *not* the alternate state.

Alternate sweep is turned off by selecting **SHIFT** ALT n again.

**NOTE**

If **ALT Swp Reg=<n>** is not the active parameter (with pointers above it), then the key sequence **SHIFT MSG** must be performed twice to turn off alternate sweep.

**NOTE**

If the attenuator setting in the selected register differs from the current setting, then the current setting is used and the **MSG** annunciator is lit, and an error message is displayed.

**Associated SCPI Commands**

<b>:SYSTem:ALTErnate &lt;n&gt;</b>	<i>Selects the instrument state in register &lt;n&gt; as the instrument state to be alternated with the current state.</i>
<b>SYSTem:ALTErnate:STATe:ON</b>	<i>Turns on the alternate sweep function.</i>
<b>SYSTem:ALTErnate:STATe:OFF</b>	<i>Turns off the alternate sweep function.</i>

**Associated 8350 Commands**

<b>AL1 &lt;n&gt;</b>	<i>Turns alternate sweep on, and selects the instrument state stored in register &lt;n&gt; as the state to be alternated with the current state.</i>
<b>AL0</b>	<i>Turns off the alternate sweep function.</i>

**————** Marker Keys



---

# Marker Keys

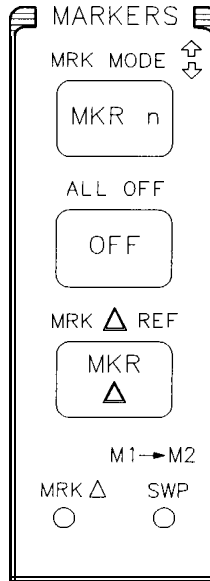



pg43ab

Figure 9-1. The Markers Group

There are ten markers: M0 through M9. Any combination of these may be on at one time, and they may be set to a frequency anywhere in the instrument's current frequency range.

When the instrument is preset (factory mode), the values of all of the markers are set to the center frequency of the instrument's frequency range. When a marker is first turned on, its initial value will be either the preset value or the last value it was set to.

If a marker has been previously set to a value outside the range of the current sweep, its value does not change when it is turned on, even though it may not be observed on a network analyzer display. If the user changes the value of such a marker using the front panel knob or the   keys, its value is

snapped to the start or stop frequency (whichever is nearest) of the sweep and is adjusted from there.

If a marker value is entered using the keypad, its value will remain as desired as long as the value is within the range of the current sweep. If the value entered falls outside of the range of the current sweep the marker's value will be snapped to the start or stop frequency (whichever is nearest to the entered number).

A marker may be on in either Sweep mode or in CW mode, but markers affect the output level (Amplitude markers) or the Z-MOD output (Intensity markers) only when the instrument is in Sweep mode. Markers do not produce these effects when the instrument is in CW mode.

The “active marker” is a marker that is turned on and whose frequency was *most recently* shown in the MARKER/SWEEP/STATUS display, even though it may not be the current active parameter being controlled by the keyboard and front panel knob. If a marker is the current active parameter, it is the “active marker” as well.

**MKR n**

Pressing the **MKR n** key allows a marker (M0–M9) to be selected and/or defined.

When this key is pressed, the MARKER/SWEEP/STATUS display shows the status of the markers in the form  $M? \text{ ON} = 0123456789$ , where each digit (0–9) is replaced by a “–” if that marker is off. When a digit (0–9) is then pressed on the Entry keyboard, the appropriate marker (M0 through M9) becomes the active parameter displayed in the MARKER/SWEEP/STATUS area, with pointers over the frequency to indicate that the marker frequency can be entered directly from the keyboard as well as with the front panel knob and **↑ ↓** keys.

The displayed marker becomes the active marker as well. Note that if another key is then pressed, making another function the active parameter, this marker remains the active marker until it is turned off, or until another marker is made the active parameter. If any markers are turned on, the MKRS annunciator is lit.

If Marker A Mode is off, the marker frequency is displayed in the format  $Mn = \langle \text{digits} \rangle \langle \text{units} \rangle$ . Eight significant figures can be displayed. Units can be MHz or GHz.

If Marker A Mode is on, the frequency *difference* between the active marker and the A Reference marker is displayed in the format  $M(n-r) = \langle \text{sign} \rangle \langle \text{digits} \rangle \langle \text{units} \rangle$ , where n is the active marker and r is the number of the A Reference marker. Five significant digits can be displayed. Units can be kHz, MHz or GHz. When Marker A Mode is on, the frequency of the active marker is still entered *directly* from the keyboard, even though the frequency *difference* is being displayed.

**Marker Scrolling** The user can quickly scroll through the frequencies of markers which have been turned on. When a marker’s frequency is displayed as the active parameter in the MARKER/SWEEP/STATUS area, with pointers over the frequency value, pressing the **←** key will move the pointers to the Mn= area of the display. Then, as the **↑ ↓** keys are pressed, or as the front panel knob is turned, the user can observe (but not change) the frequencies of all markers which are turned on. To change the value of an observed marker, the **Hz/s/ENTER** key must be pressed, thereby making this marker become the active parameter, with pointers over the frequency value. Or, while in the marker scrolling mode, the user can also turn on a particular marker and make it become the active parameter, by pressing the corresponding number (0–9) key.

Associated **SCPI** Commands

**MARKer** [n] [:STATe] ON *Same as pressing the [[MKR n]] key.*  
**MARKer** [n] :FREQuency *Enters frequency of marker.*  
 <num> [suffix]

## Associated 8350 Commands

**M** <n> <num> [suffix] *Same as pressing [[MKR n]] key.*  
**MA** <num> [suffix] *Used to set marker 0.*

**MKR MODE** When this function is selected (by pressing **SHIFT** **MKR n**), the current marker output format is displayed. The mode can be changed to the next choice by pressing the **↑** **↓** keys, or by selecting **SHIFT** **MKR MODE** again. The marker output format choices are:

**Amplitude** In this mode the on markers appear as a rise of about 1 dB in the output power. The displayed message is **Markers=Amplitude**.

**Intensity** In this mode the on markers appear as a -5V pulse at the Z-AXIS BLANK/MKRS rear panel output connector. The displayed message is **Markers=Intensity**.

**NOTE**

The Z-axis markers are always on, so it is not possible to have amplitude markers on, and intensity markers off.

**MKR n**

Associated **SCPI** Commands

**MARKer:AMPLitude[:STATe] ON**      *Selects marker amplitude mode.*

**MARKer:AMPLitude[:STATe] OFF**      *Selects marker intensity mode.*

Associated 8350 Commands

**AK1**      *Selects marker amplitude mode.*

**AK0**      *Selects marker intensity mode.*

OFF

This key turns off a marker only if it is displayed in the MARKER/SWEEP/STATUS area as the active parameter.

Note that the pointers must be over the frequency value. The instrument then returns to the same state as if **MKR n** had just been pressed, displaying the new status of which markers are on and off. The A Reference marker cannot be turned off if Marker A Mode is turned on. The MKRS annunciator is turned off only if all the markers are off.

Associated **SCPI** Commands

**MARKer[n] [:STATe] OFF** *Turns marker [n] off.*

## Associated 8350 Commands

**M<n> MO** *Turns marker <n> off.*

**ALL OFF**

This function turns off all the markers, regardless of the active parameter. The instrument then returns to the same state as if **MKR n** had just been pressed, displaying M? On=------. The MKRS annunciator is turned off. Marker A Mode is also turned off.

Associated **SCPI** Commands

**MARKer:AOff** *Turns all markers off.*

## Associated 8350 Commands

**SHMO** *Turns all markers off.*

**MKR Δ**

This key toggles the marker A mode on and off.

If marker A mode is off when this key is pressed the following things happen:

- The marker A mode is turned on,
- the active marker becomes the active parameter,
- and the *difference* frequency between this marker and the A Reference Marker is displayed in the MARKER/SWEEP/STATUS area in the format  $M(n - r) = \langle \text{sign} \rangle \langle \text{digits} \rangle \langle \text{units} \rangle$ , where n is the active marker and r is the number of the A reference marker.
- The MKR A LED annunciator is turned on,
- and MARKer:MODE is set to DELTA.
- The A reference marker is turned on and cannot be turned off while Marker A mode is on.
- If no marker was the active marker since the last time **PRESET** was pressed, M2 becomes the default active marker.

If marker A mode is on when this key is pressed, the following things happen:

- The mode is turned off
- the active marker becomes the active parameter displayed in the MARKER/SWEEP/STATUS area
- the MKR A LED annunciator is turned off
- and MARKer:MODE is set to FREQuency

Associated **SCPI** Commands

**MARKer**[n]:MODE FREQuency|DELTA *Same as pressing [[MKR Δ]].*

**MARKer**[n]:DELTA? <num>, <num> *Used to query over HP-IB.*

## Associated 8350 Commands

**SMH1** <n1> <n2> *Sets marker Δ mode to on.*

**MKR Δ REF** This key is used to select a marker as the A marker.

When this key is pressed, the user can select which marker (0-9) is the A Reference Marker. The marker number becomes the active parameter which is displayed in the MARKER/SWEEP/STATUS area. The A Reference Marker is turned on if Marker A Mode is turned on. The display is in the format **Mkr Delta Ref = <n>**. If a number (0-9) is entered from the keyboard, the **Hz/s/ENTER** key must be used to terminate the entry. If no other marker has been selected, M1 is the default A Reference Marker.

Associated **SCPI** Commands

**MARKer[n]:REFerence <n>**

*Sets marker <n> as the Δ reference marker.*

---



**————** Modulation Keys

---

# Modulation Keys

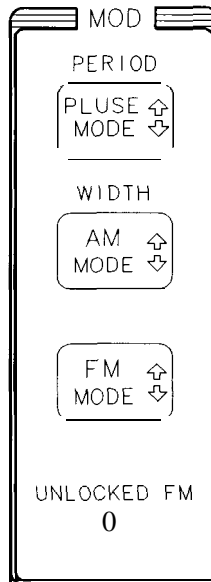

pg44ab

Figure 10-1. The Modulation Group

AM and FM modulation is obtained by means of an external signal being applied to the rear-panel AM INPUT or FM INPUT BNC connectors. There are 2 FM modes: AC (locked) and DC (unlocked).

**NOTE**



In the DC (unlocked) mode, frequency accuracy will be degraded as a result of the synthesizer being bypassed.

Pulse modulation is either internal or external. Internal pulse modulation is either controlled by a built-in pulse generator, or preset to either a 1 kHz or a 27 kHz square wave. When external pulse is selected, the instrument is modulated by a signal present on the PULSE IN/OUT connector on the rear panel.

When external modulation is enabled, the EXT MOD annunciator is turned on. When internal modulation is enabled, the INT MOD annunciator is turned on.

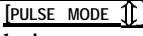

Pressing the  key displays the current pulse mode and allows it to be changed if desired.

When this key is pressed, the current Pulse Mode is shown in the MARKER/SWEEP/STATUS display. The mode can be changed to the next choice by pressing the  key again, or by pressing the   keys. The pulse mode choices are:

- Pulse Mod Off In this mode, pulse modulation is turned off. Any modulation related annunciators (INT MOD or EXT MOD) are turned off. The displayed message is `Pulse= Mod Off`.
- Internal Pulse In this mode, pulse modulation is controlled by an internal pulse generator. For CW mode below 500 MHz or Swept mode below 2 GHz, minimum leveled pulse width is degraded. The INT MOD annunciator is turned on. The displayed message is `Pulse= Internal`.
- External Pulse In this mode, pulse modulation is from the rear-panel PULSE IN/OUT BNC connector. For CW mode below 500 MHz or Swept mode below 2 GHz, minimum leveled pulse width is degraded. The EXT MOD annunciator is turned on. The displayed message is `Pulse= External`.
- 1 kHz Square Wave In this mode, pulse modulation is a 1 kHz square wave. The INT MOD annunciator is turned on. The displayed message is `Pulse= 1 kHz Sq`.
- Scalar In this mode, pulse modulation is a 27.778 kHz square wave, for use with scalar analyzers. The INT MOD annunciator is turned on. The displayed message is `Pulse= Scalar`. The rise and fall times of the RF envelope are approximately 1  $\mu$ s in this mode.

**Associated SCPI Commands**

PULM:SOURce <b>INTernal</b>	<i>Sets the pulse mode to internal.</i>
PULM:SOURce <b>SCALar</b>	<i>Sets the pulse mode to scalar.</i>
PULM:SOURce <b>EXTernal</b>	<i>Sets the pulse mode to external.</i>
PULM:SOURce <b>SQ1K</b>	<i>Sets the pulse mode to 1 kHz square wave.</i>
PULM:STATe ON	<i>Turns the selected pulse mode on.</i>
PULM:STATe OFF	<i>Turns pulse modulation off.</i>

**Associated 8350 Commands**

<b>PM1</b>	<i>Turns pulse modulation on.</i>
<b>PM0</b>	<i>Turns pulse modulation off.</i>
<b>MD1</b>	<i>Turns square wave modulation on.</i>
<b>MDO</b>	<i>Turns square wave modulation off.</i>

**PERIOD** When this function is selected (by pressing (SHIFT) (PULSE MODE  $\updownarrow$ )) the pulse period becomes the active parameter. This parameter applies to the internal pulse mode.



Its value is shown in the MARKER/SWEEP/STATUS display, in the format **Period= <digits><units>**. Units can be  $\mu$ s or ms. The range of accepted values is 2  $\mu$ s to 65.53 ms. Resolution is 1  $\mu$ s. If necessary, the pulse width will be decreased to be 1  $\mu$ s less than the entered period value. In other words, the period must always be  $\geq$  width + 1  $\mu$ s.

**Associated SCPI Commands**

PULSe:PERiod<num>[ <b>suffix</b> ]	<i>Sets the pulse period to the desired value.</i>
------------------------------------	--

**AM MODE** 

Pressing the **AM MODE**  key displays the current AM mode and allows it to be changed if desired.

When this key is pressed, the current AM mode is displayed in the MARKER/SWEEP/STATUS display. The mode can be changed to the next choice by pressing the **AM MODE**  key again, or by pressing the   keys. The AM mode choices are:

- |             |  |
|-------------|--|
| AM Off      | In this mode, external AM modulation is disabled. The displayed message is <code>AM=Off</code> .   |
| External AM | In this mode, external AM modulation is enabled. The EXT MOD annunciator is turned on. The displayed message is <code>AM=External</code> . |

**Associated SCPI Commands**

<b>AM:STATe</b> ON	<i>Turns external AM modulation on.</i>
<b>AM:STATe</b> OFF	<i>Turns external AM modulation off.</i>

**WIDTH** When this function is selected (by pressing **SHIFT** **AM MODE** ) the pulse width becomes the active parameter. This parameter applies to the internal pulse mode.

Its value is shown in the MARKER/SWEEP/STATUS display, in the format `Width= <digits><units>`. Units can be either  $\mu\text{s}$  or ms. The range of accepted values is 1  $\mu\text{s}$  to 65.53 ms. Resolution is 1  $\mu\text{s}$ . If necessary, the pulse period will be increased to be 1  $\mu\text{s}$  greater than the entered width value. In other words, the period must always be  $\geq$  width + 1  $\mu\text{s}$ .

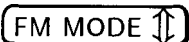

Pressing the **(FM MODE St)** key displays the current FM mode and allows it to be changed if desired.

When this key is pressed the current FM mode is displayed in the MARKER/SWEEP/STATUS area. The mode can be changed to the next choice by pressing the **(FM MODE St)** key again, or by pressing the **(↑)** **(↓)** keys. The FM mode choices are:

- |                |   |
|----------------|---|
| FM Off         | In this mode, external FM modulation is disabled. The displayed message is <code>FM=OFF</code> .  |
| AC/Locked FM   | In this mode, the RF output signal is synthesized, and external FM modulation is enabled. The bandwidth is restricted to above approximately 50 kHz. The user is cautioned that the low-frequency deviation is limited in this mode to approximately 25 times the rate of the signal. The front-panel EXT MOD annunciator is turned on. The displayed message is <code>FM=AC/Locked</code> .                    |
| DC/Unlocked FM | In this mode, the RF output signal is <i>not synthesized</i> , and external FM modulation is enabled, with a bandwidth that is dc-coupled. In this mode, the RF frequency accuracy and residual FM are <i>severely</i> degraded, and may be out of spec. The front-panel UNLOCKED FM LED annunciator is turned on, The EXT MOD annunciator is turned on. The displayed message is <code>FM=DC/Unlocked</code> . |

#### Associated **SCPI** Commands

FM:COUPling AC	<i>Sets the FM mode to AC/locked FM.</i>
FM:COUPling DC	<i>Sets the FM mode to DC/Unlocked FM.</i>
FM:STATe ON	<i>Turns on the selected FM mode,</i>
FM:STATe OFF	<i>Turns FM mode off.</i>

————— Frequency Keys



---

# Frequency Keys

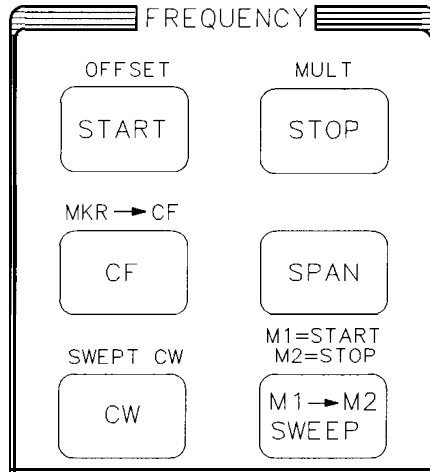

pg45ab

Figure 1 I-I. The Frequency Group

All the frequency functions, with the exception of the multiplier setting (see “ **MULT** ”), accept parameters with the units of hertz. Therefore, the numeric entries must be terminated using one of the four frequency-unit keys (**GHz**), (**MHz**), (**kHz**) or (**Hz**). When the entry is terminated, the display shows the new value, autoranged to the appropriate units.

For Start/Stop and CF/Span Sweep modes, the frequency values are shown on the left and right sides of the FREQUENCY display, in the format <digits> <units>. Units can be either MHz or GHz. Leading zeros are suppressed.

For CW mode, the frequency is shown in the FREQUENCY display in the format <digits> <units>. Units can be either MHz or GHz. Leading zeros are suppressed.

All the frequency functions share a common step size (this includes the frequency of the markers). A step that would move a frequency beyond its legal range is not taken, allowing you to “retrace your steps” by stepping in the opposite direction.

The maximum and minimum frequencies are dependent upon the model number of your sweeper and are documented in the “Specifications and Options” chapter of this manual.

The instrument can only sweep up in frequency, therefore the STOP frequency cannot be less than the START frequency. If a start frequency is entered which is greater than the stop frequency, then the stop frequency becomes equal to the start; if a stop frequency is entered which is less than the start frequency, then the start becomes equal to the stop.

**START**

Pressing the **START** key puts the instrument into the swept frequency mode, and allows you to change the start frequency.

This key puts the instrument into sweep mode, and displays the start and stop frequencies on the FREQUENCY display. The START and STOP annunciators are turned on when this key is pressed. Pressing **START** makes the start (lower) frequency the active parameter. Attempting to set the start frequency above the stop frequency causes the stop frequency to increase. The start frequency is always coupled to a previously-set CF and Span by the equation:  $START = CF - SPAN/2$ .

Associated **SCPI** Commands

<b>FREQUENCY:MODE:SWEEP</b>	<i>Sets the instrument to sweep mode.</i>
<b>FREQUENCY:START &lt;num&gt;[suffix]</b>	<i>Sets the start frequency to the desired value.</i>

## Associated 8350 Commands

<b>FA &lt;num&gt;[suffix]</b>	<i>Sets the start frequency to the desired value.</i>
-------------------------------	---

**OFFSET**

When this function is selected (by pressing **SHIFT** **START**) the frequency offset becomes the active parameter displayed in the MARKER/SWEEP/STATUS area. If the offset frequency is not zero, the OFFSET annunciator is turned on. The values of frequency shown in the FREQUENCY display are in accordance with the equation:

Displayed Frequency = (Actual RF Frequency \* Multiplier) + Offset

The frequency offset is displayed in the format **Offset = <sign><digit> <unit>**. Units can be kHz, MHz or GHz. A positive (+) or negative (-) value can be entered. Frequency offset can be turned off by selecting **SHIFT**

**OFFSET** again, or by setting the offset to 0 Hz.

**Associated SCPI Commands**

FREQUENCY:OFFSET <num>      *Sets the frequency offset to the desired value.*

FREQUENCY:OFFSET:STATE ON      *Turns the frequency offset on.*

FREQUENCY:OFFSET:STATE OFF      *Turns the frequency offset off.*

**Associated 8350 Commands**

SHFB <num>[suffix]      *Sets the frequency offset to the desired value.*

**STOP**

Pressing the (STOP) key puts the instrument into the swept frequency mode, and allows you to change the stop frequency.

This key puts the instrument into sweep mode, and displays the start and stop frequencies on the FREQUENCY display. The START and STOP annunciators are turned on. The stop (upper) frequency becomes the active parameter. Attempting to set the stop frequency below the start frequency causes the start frequency to decrease. The stop frequency is always coupled to a previously-set CF and Span by the equation:  $STOP=CF+SPAN/2$ .

**NOTE**

Although the sweeper is only specified to 20 GHz, the stop frequency can be set as high as 20.5 GHz.

**Associated SCPI Commands**

<code>FREQUENCY:MODE SWEep</code>	<i>Sets the instrument to sweep mode.</i>
<code>FREQUENCY:STOP&lt;num&gt;[suffix]</code>	<i>Sets the stop frequency to the desired value.</i>

**Associated 8350 Commands**

<code>FB &lt;num&gt;[suffix]</code>	<i>Sets the stop frequency to the desired value.</i>
-------------------------------------	--

**MULT** Selecting this function (by pressing **SHIFT** **STOP**) makes the frequency multiplier the active parameter displayed in the MARKER/SWEEP/STATUS area. If the multiplier is not 1, the MULT annunciator is turned on. The values of frequency shown in the FREQUENCY display are in accordance with the equation:

$\text{DisplayedFrequency} = (\text{Actual RF Frequency} * \text{Multiplier}) + \text{Offset}$

The multiplier value is displayed in the format **MULTIPLIER=<digits>**.

The value must be an integer between 1 and 36. There are no units. The multiplier function can be turned off by selecting **SHIFT** **MULT** again, or by setting the multiplier to 1.

#### Associated SCPI Commands

<b>FREQUENCY:MULTIPLIER &lt;num&gt;</b>	<i>Sets the frequency multiplier to the desired value.</i>
<b>FREQUENCY:MULTIPLIER:STATE ON</b>	<i>Turns the frequency multiplier function on.</i>
<b>FREQUENCY:MULTIPLIER:STATE OFF</b>	<i>Turns the frequency multiplier function off.</i>

#### Associated 8350 Commands

<b>SHFA &lt;numeric value&gt;</b>	<i>Sets the frequency multiplier to the desired value.</i>
-----------------------------------	--

**CF**

Pressing the **CF** key puts the instrument into the swept frequency mode, and allows you to change the center frequency of the sweep.

This key puts the instrument into sweep mode and displays the center frequency and frequency span in the FREQUENCY display. The CF and SPAN Annunciators are turned on. The center frequency becomes the active parameter. If the center frequency is changed to a value that would put one end of the span beyond the legal range of the start and stop frequencies, then the span is reduced to keep the start and stop frequencies in range. The center frequency is always coupled to previously-set start and stop frequencies by the equation:  $CF = (START + STOP) / 2$ .

#### Associated SCPI Commands

**FREQUENCY:MODE SWEep** *Sets the instrument to sweep mode.*  
**FREQUENCY:CENTer <num>[suffix]** *Sets the center frequency to the desired value.*

#### Associated 8350 Commands

**CF <num>[suffix]** *Sets the center frequency to the desired value.*

**MKR → CF** When this function is selected (by pressing **(SHIFT) CF**), the center frequency becomes the value of the active marker. The span width does not change. If all markers are off when this key is pressed, then no action takes place. This function works in either Start/Stop or CF/Span modes.

#### Associated SCPI Commands

**MARKer [n]:FREQUENCY ?** *Retrieves the value of the marker.*  
**FREQUENCY:CENTer <freq from above>[suffix]** *Sets the center frequency to the value of the marker.*

#### Associated 8350 Commands

**MC** *Sets the center frequency to the value of the active marker.*

## SPAN

Pressing the (SPAN) key puts the instrument into the sweep mode and allows the span of the sweep to be changed.

This key puts the instrument into sweep mode and displays the center frequency and frequency span in the FREQUENCY display. The CF and SPAN annunciators are turned on. The frequency span becomes the active parameter. If the span is changed to a value that would put one end of the sweep beyond the legal range of the start and stop frequencies, then the center frequency is adjusted so that the end of the sweep is a valid frequency, while keeping the span the same. The span frequency is always coupled to previously-set start and stop frequencies by the equation:  
 $SPAN = (STOP - START)$ .

Associated **SCPI** Commands

<b>FRE</b> quency:MODE SWEep	<i>Sets the instrument to sweep mode.</i>
<b>FRE</b> quency:SPAN <num>[suffix]	<i>Sets the frequency span to the desired value.</i>

## Associated 8350 Commands

DF <num>[suffix]	<i>Sets the frequency span to the desired value.</i>
------------------	--



**CW** Pressing the **CW** key sets the instrument to CW (continuous wave) mode and allows the CW frequency to be changed.

This key turns the sweep mode off, and displays the CW frequency in the FREQUENCY display. (The right half of the FREQUENCY display is blanked.) The CW Annunciator is turned on. The CW frequency becomes the active parameter. If marker sweep mode is on, it will be turned off.

**CW/CF Coupling** The CW frequency can be set independently of Start/Stop/CF/Span, or can be coupled to them, depending on whether CW/CF Coupling is turned on or off. CW/CF coupling is turned off in the factory preset condition. When coupling is turned on, CW=CF.

To turn on CW/CF coupling:

Press <b>key(s)</b> :	Display reads:
<b>SPECIAL</b>	Last special function accessed.
1 <b>Hz/s/ENTER</b>	CwCf Aut o=OFF
↑	CwCf Aut.o=ON

**Associated SCPI Commands**

<b>FREquency:MODE CW FIXed</b>	<i>Sets the instrument to CW mode.</i>
<b>FREquency[:CW FIXed]:AUTO ON</b>	<i>Turns the CW/center frequency coupling on.</i>
<b>FREquency[:CW FIXed]:AUTO OFF</b>	<i>Turns the CW/center frequency coupling off.</i>
<b>FREquency:CW FIXed &lt;num&gt;[suffix]</b>	<i>Sets the CW frequency to the desired value.</i>

**Associated 8350 Commands**

<b>CW &lt;num&gt;[suffix]</b>	<i>Sets the CW frequency to the desired value.</i>
-------------------------------	--

**SWEPT CW** Operates the same as pressing the **CW** key, except that sweep mode is turned on, and the 0 to 10 V ramp is available at the SWEEP OUT BNC connectors on the front and rear panels.

This mode allows power sweep and power slope in CW mode.

Associated **SCPI** Commands

**FREQUENCY:MODE SWEep** *Sets the instrument to sweep mode.*

**FREQUENCY[:CW|FIXed] :AUTO ON|OFF** *Turns CW/CF coupling on or off.*

**FREQUENCY:CW|FIXed <num>[suffix]** *Sets CW to the desired frequency.*

**FREQUENCY:SHCW <num>[suffix]** *Sets swept CW to desired frequency.*

Associated 8350 Commands

**SHCW <num>[suffix]** *Turns swept CW on.*

**M1→M2/SWEEP**

Pressing the **M1→M2/SWEEP** key turns markers M1 and M2 on, and sweeps between the two markers.

This function toggles marker sweep mode on and off. If marker sweep mode is off when this key is pressed, the mode is turned on and the **M1→M2 SWP** LED annunciator is turned on. Markers M1 and M2 are turned on if they were previously off, and the instrument sweeps from a start frequency of marker M1 to the stop frequency of marker M2.

**NOTE**

If the value of M1 is greater than the value of M2, their values will be interchanged when they are put into the start and stop frequencies.

In this mode, the FREQUENCY display shows M1 as the start frequency and M2 as the stop frequency. The START, STOP, CF and SPAN values are coupled with markers M1 and M2. That is, any change in the values of START and STOP frequency will directly alter the values of markers M1 and M2, and vice versa. If the frequency of marker M1 or M2 is the active parameter displayed in the MARKER/SWEEP/STATUS area, and if its value is changed, or if new START, STOP, CF, or SPAN frequencies are entered, then *both* the FREQUENCY and the MARKER/SWEEP/STATUS displays are updated simultaneously to the new value.

When marker sweep is toggled off, by pressing **M1→M2/SWEEP** again, the START, STOP, CF and SPAN values will revert to what they had been before marker sweep was turned on. The **M1→M2** LED annunciator will be turned off, but M1 and M2 will remain on.

**Associated SCPI Commands**

<b>SWEEP:MARKer:STATe</b> ON	<i>Turns marker sweep on.</i>
<b>SWEEP:MARKer:STATe</b> OFF	<i>Turns marker sweep off.</i>

## Associated 8350 Commands

<b>MP1</b>	<i>Turns marker sweep on.</i>
<b>MPO</b>	<i>Turns marker sweep off.</i>

**M1=START**  
**M2=STOP** This function copies the values of the markers M1 and M2 to the START and STOP frequencies respectively. The new frequencies are then shown in the FREQUENCY displays. Markers M1 and M2 are turned on if they were previously off. Also, if M1→M2 Sweep mode is on, it will be automatically turned off when this function is selected.

**NOTE**

If the value of M1 is greater than the value of M2, the values will be interchanged when they are put into the start and stop frequencies. However, the values stored in M1 and M2 will not change.

Associated **SCPI** Commands

**SWEep:MARKer:XFER** *Transfers values of M1 and M2 to the start and stop frequencies.*

## Associated 8350 Commands

**SHMP** *Transfers values of M1 and M2 to the start and stop frequencies.*

———— Sweep Keys

---

# Sweep Keys

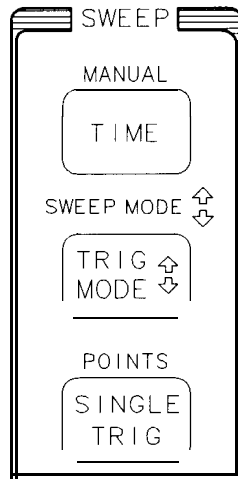

pg46ab

Figure 12.1. The Sweep Group

There are two sweep modes: analog (or ramp) and stepped. In analog sweep mode, the duration of the forward-going portion of the sweep is controlled and displayed. In stepped sweep mode, the dwell time per point is controlled and displayed. The remainder of the cycle time depends on the trigger mode selected, the number of bandswitches required, the time required for each bandswitch, and retrace/settling times. In addition, there is a manual sweep mode, in which the sweep position can be continuously adjusted over the start/stop range as determined by the front panel (manual) control. Manual sweep mode operates independently of whether analog or stepped mode is selected.

The instrument has only one sweep generator, so both frequency sweep and power sweep use the same sweep parameters. The SWEEP annunciator on the left FREQUENCY display is lit *only* while the instrument is actually sweeping.

**NOTE**

The **SWEEP** annunciator is on all the time during fast sweeps and cycles on and off for slower sweeps, however it is not necessarily an accurate indicator of when the instrument is actually in a forward sweep.

**TIME**

Pressing the (TIME) key displays the sweep time and allows it to be changed.

If this key is pressed when analog sweep mode is on, the time for the forward portion of the sweep becomes the active parameter, and is shown in the MARKER/SWEEP/STATUS display.

If manual sweep mode is on, it will be turned off.

If this key is pressed when stepped sweep mode is on, the dwell time per point becomes the active parameter, and is shown in the MARKER/SWEEP/STATUS display.

The minimum value of sweep time which may be entered is a function of the desired frequency range. The last entered value of sweep time is compared to this limit, even after the frequency range is readjusted. If the entered value is less than the limit, then the limit value is used, and if the entered value is greater than the limit, then the entered value is used.

The Sweep time is displayed as `SweepTime=<digits><units>`. The dwell time is displayed as `DwellTime=<digits><units>`. Units can be either ms or s.

Step size cannot be set for sweep and dwell time. It is a 1,2,5 data progression like 10 ms, 20 ms, 50 ms, etc. The SWEEP annunciator on the left FREQUENCY display is lit *only* during the time the instrument is actually sweeping.

**NOTE**

The **SWEEP** annunciator is on all the time during fast sweeps and cycles on and off for slower sweeps, however it is not necessarily an accurate indicator of when the instrument is actually in a forward sweep.



**Associated SCPI Commands**

<code>SWEep:MODE AUTO</code>	<i>Turns autosweep on (turns manual sweep off).</i>
<code>SWEep:TIME:AUTO ON</code>	<i>Automatically sets the sweep time to the minimum value.</i>
<code>SWEep:TIME:AUTO OFF</code>	<i>Sweep time is left at current setting unless other parameter changes initiate a change.</i>
<code>SWEep:DWELL &lt;num&gt;[suffix]</code>	<i>Sets the dwell time to the desired value.</i>
<code>SWEep:TIME&lt;num&gt;[suffix]</code>	<i>Sets the sweep time to the desired value.</i>

**Associated 8350 Commands**

<code>ST &lt;num&gt;[suffix]</code>	<i>Sets the sweep time to the desired value.</i>
-------------------------------------	--

See Also Chapter 15, Special Function 4 - STEP SWPTIME

**MANUAL** Selecting this function (by pressing [**SHIFT**]**TIME**) turns the manual sweep mode on. Depending on what parameter is being swept; frequency, power, or sweep position can be varied manually over the limits defined by start/stop, power sweep, etc. The MAN annunciator is turned on. To turn manual sweep mode off, the **TIME** key must be pressed.

If frequency is being swept manually, the current frequency is displayed as the active parameter in the MARKER/SWEEP/STATUS display area in the form `MAN=<digits><units>`. Units can be either GHz or MHz.

If frequency is not being swept, the sweep position is displayed as the active parameter in the MARKER/SWEEP/STATUS area in the form `MAN=xx.xxx%`. In power sweep mode, the manual power level is displayed as the active parameter in the MARKER/SWEEP/STATUS area in the form `MAN=xx.xdBm`.



Associated **SCPI** Commands



- SWEep:MODE **MAN**ual** *Sets the instrument to manual sweep mode.*
- FREQuency:MANual <num>[**suff**ix]** *Sets the manual frequency to the desired value.*
- SWEep:MANual:[:**REL**ative] <num>** *Used for power sweep.*

Associated 8350 Commands

- SM <num>[**suff**ix]** *Sets the instrument to manual sweep.*

**TRIG MODE** 

Pressing the **TRIG MODE**  key displays the current trigger mode and allows it to be changed.

When this key is pressed, the current trigger mode is displayed in the MARKER/SWEEP/STATUS display area. The mode can be changed to the next choice by pressing the **TRIG MODE**  key again, or by pressing the   keys. The trigger mode choices are:

Continuous Trigger	In this mode the sweep is initiated as soon as possible after the last sweep. The displayed message is <code>Swp Trig=Cont.</code>
External Trigger	In this mode the sweep is initiated by a positive edge of the TTL-compatible rear-panel external TRIGGER INPUT. There will be about 1 ms of delay between the positive edge and when the sweep actually starts. The displayed message is <code>Swp Trig=Extern.</code>

**NOTE**

External Trigger mode will not work if Step Sweep External Trigger mode is selected.

**Single Trigger** In this mode the sweep is initiated when the user presses **SINGLE/TRIG**, or by the HP-IB bus. The displayed message is `Swp Trig=Single.`





**Associated SCPI Commands**

<b>INITiate:CONTInuous ON</b>	<i>Sets the trigger mode to continuous.</i>
<b>TRIGger:SOURceIMMediate</b>	<i>Sets the sweep to be triggered immediate&amp; after the last sweep.</i>
<b>TRIGger:SOURce EXTernal</b>	<i>Sets the sweep to be triggered by the external trigger input signal.</i>
<b>INITiate:CONTInuous OFF</b>	<i>Sets the trigger mode to single.</i>
<b>ABORT</b>	<i>Causes a sweep in progress to abort and reset.</i>
<b>INITiate[:IMMediate]</b>	<i>Causes the initiation of a sweep.</i>

TRIG MODE 

## Associated 8350 Commands

T1	<i>Sets trigger mode to continuous, internal.</i>
T3	<i>Sets trigger mode to external</i>
T4	<i>Sets trigger mode to single.</i>

**SWEEP MODE**  When this function is selected (by pressing **SHIFT** **TRIG MODE** ), the current sweep mode is displayed in the MARKER/SWEEP/STATUS display area. The mode can be changed to the next choice by pressing the **SHIFT** **TRIG MODE**  keys again, or by pressing the   keys. Note that selecting manual sweep overrides this selection. The sweep mode choices are:

Analog Sweep	In this mode, analog (or ramp) sweep mode is enabled. The display shows <code>Sweep=Ana 1 0g</code> .
Step Sweep/Cont Trig	In this mode, stepped sweep mode is enabled. After dwelling at each point, the sweep steps to each new point as soon as possible. The STEP annunciator is turned on. The display shows <code>Sweep=St ep Cont</code> .

**NOTE**

Stepped sweep mode cannot be used with the alternate sweep mode (**ALT n**), or External Trigger mode.

Step Sweep/External Trig	In this mode, stepped sweep mode is enabled. After dwelling at each point, the sweep steps to each new point on a positive edge of the TTL-compatible rear-panel external TRIGGER INPUT. There will be some delay between the positive edge and when sweep actually starts (typically about 2 ms). The STEP annunciator is turned on. The display shows <code>Sweep=St ep Ext. ''</code> .
--------------------------	--

Associated **SCPI** Commands

<b>SWEep:GENerationANALog</b>	<i>Sets the sweep mode to analog.</i>
<b>SWEep:GENerationSTEPped</b>	<i>Sets the sweep mode to stepped.</i>
<b>SWEep:TRIGger:SOURce IMMEDIATE</b>	<i>Sets the instrument to internal &amp; trigger as soon as possible after the last trigger.</i>
<b>SWEep:GENerationSTEPped</b>	<i>Sets the sweep mode to stepped.</i>
<b>SWEep:TRIGger:SOURce EXTERNAL</b>	<i>Sets the instrument to externally trigger a step.</i>

**SINGLE/TRIG**

Pressing the **(SINGLE/TRIG)** key triggers a single sweep in the instrument. If the trigger mode was not previously set to single trigger, pressing this key will automatically set the trigger mode to single.

**POINTS**

This function (selected by pressing **(SHIFT) (SINGLE/TRIG)**) sets the number of points in a stepped sweep. When this key is pressed, the number of points becomes the active parameter and is displayed in the MARKER/SWEEP/STATUS display in the form `SweepPoints= XXX`. The acceptable range of values is 2 to 1601. The total forward sweep time in stepped sweep mode can be computed from the equation:  
**SweepTime= Number of Points \* (DwellTime + Switching Time)**, where Switching Time is typically 7 ms + 8ms/GHz step.

**Associated SCPI Commands**

`SWEEP:POINTS <numeric value>`      *Sets the number of points to the desired value.*

**————** Power Keys

---

# Power Keys

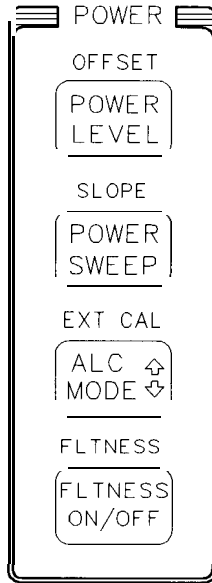

pg47ab

**Figure 13.1.** The Power Group

The power functions are displayed in the right-hand display, either in the MARKER/SWEEP/STATUS area or in the POWER area, as described for each function. Units are not autoranged, and are given below for each function.



**POWER LEVEL**  
changed

Pressing this key displays the current power level and allows it to be

This function makes the power level the active parameter displayed in the POWER area. The units are dBm. If power sweep mode is engaged, the power at the start of the sweep is displayed. If power slope mode is engaged, the power that would be present at 0 Hz (i.e. without frequency-slope correction) is displayed. If RF is turned off, the power level that would be present if RF were turned on is displayed.

The display format is XX.XdBm. Power is settable to 0.01 dB, with 0.1 dB display resolution.

#### Associated SCPI Commands

**POWER: [LEVEL] <num> [DBM]**      *Sets the power level to the desired value.*

#### Associated 8350 Commands

**PL <num> [suffix]**      *Sets the power level to the desired value.*

**OFFSET** Selecting this function (by pressing (SHIFT) (POWER/LEVEL)) adjusts the POWER display to make it agree with the RF power at a remote location. When this key is pressed, power offset becomes the active parameter displayed in the MARKER/SWEEP/STATUS area. If the power offset is not zero, the POWER display units are changed to dB\* rather than dBm, and the POWER display shows the power level at the remote site, *NOT* the power level at the RF OUTPUT.

This function does not affect the actual RF output power, only the display, in accordance with the equation:

DisplayedPower=ActualRF Output Power – Offset.

As the offset value is changed, *both* the POWER and the MARKER/SWEEP/STATUS displays are updated to the new values of power and offset respectively. The display format is Power Offset=XX.XdB.

**POWER LEVEL**)

Resolution is 0.1 dB. The power offset function can be turned off by selecting **SHIFT** OFFSET again, or by setting the power offset to 0.0 dB.

Associated **SCPI** Commands

POWER:OFFSet <num> [DB]

*Sets the power offset to the desired value.*

## POWER/SWEEP

Pressing the **POWER/SWEEP** key displays the power sweep value and allows it to be changed.

This function controls the change in RF power as the instrument sweeps, with units of dB/Sweep. If this key is pressed when power sweep mode is off, or when another parameter is displayed in the MARKER/SWEEP/STATUS area, then power sweep becomes the active parameter, and the PWR SWP annunciator is turned on. Pressing the key again turns power sweep mode off, and turns the PWR SWP annunciator off.

A positive or negative value may be entered. The power must remain within the ALC leveling range, and may not cross an attenuator boundary.

The value of power at the start of the sweep will be displayed in the POWER area, and will be automatically varied if necessary to keep the power within the ALC leveling range. The display format is Pwr Sweep= XX. XdB. Resolution is 0.1 dB.

## Associated SCPI Commands

POWER:MODE SWEEP	<i>Turns power sweep mode on.</i>
POWER:MODE FIXED	<i>Turns power sweep mode off.</i>
POWER:START <num> [DBM]	<i>Sets the start of the power sweep to the desired value.</i>
POWER:SPAN<num> [DBM]	<i>Sets the power span to the desired value.</i>

## Associated 8350 Commands

PSI <num> [suffix]	<i>Turns power sweep on.</i>
PSO	<i>Turns power sweep off.</i>

**SLOPE** Selecting this function (by pressing **SHIFT** **POWER SWEEP**) controls the power slope, which is the change in power per unit frequency. This function is used to increase the RF power by a constant dB amount per unit RF frequency in GHz, to compensate for the power loss of an external device or cable. The units are dB/GHz. Selecting this function makes power slope the active parameter, displayed in the MARKER/SWEEP/STATUS area. If the power slope is not zero, the SLOPE annunciator is turned on. A positive or negative value may be entered. The power must remain within the ALC leveling range, and may not cross an attenuator boundary.

The value of power without power slope correction (i.e. at 0 Hz) is displayed in the POWER area. The display format is `Slope= X.XX dB/GHz`. Resolution is 0.01 dB. The power slope function can be turned off by selecting **SHIFT** **SLOPE** again, or by setting the slope to 0.00 dB/GHz.

#### Associated **SCPI** Commands



<code>POWER:SLOPe:STATe</code>	<code>ON</code>	<i>Turns power slope on.</i>
<code>POWER:SLOPe:STATe</code>	<code>OFF</code>	<i>Turns power slope off.</i>
<code>POWER:SLOPe</code>	<code>&lt;num&gt; [DB]</code>	<i>Sets the slope to the desired value.</i>



#### Associated 8350 Commands

<code>SL1 &lt;num&gt; [suffix]</code>	<i>Turns power slope on.</i>
<code>SLO</code>	<i>Turns power slope off.</i>

**ALC MODE** 

Pressing the **ALC MODE**  key displays the current ALC mode and allows it to be changed.

When this key is pressed the current ALC mode is displayed in the MARKER/SWEEP/STATUS area. The mode can be changed to the next choice by pressing the key again, or by pressing the   keys. The ALC mode choices are:

- |                   |   |
|-------------------|---|
| Internal Leveling | The ALC point is inside the source. The displayed message is <code>ALC=Internal</code> .  |
| Unleveled         | The ALC circuitry is turned off. This will cause the UNLEV annunciator to light. Provides uncalibrated level control by allowing direct control of the internal linear modulators and step attenuator. The modulator is set by using the front panel knob or the   key. A 1 dB change in modulator setting corresponds to an approximately 1 dB change in output power. The displayed message is <code>ALC=Unleveled</code> . |

**NOTE**

If your sweeper has option 1E1 (add step attenuator), the ALC and the attenuator are uncoupled when your sweeper is in the following ALC modes. This will be indicated to you by the front panel display annunciator, `UNCPLD`.

- |                         |   |
|-------------------------|---|
| External Diode Leveling | The ALC point is fed from an external diode detector. This mode requires an external feedback connection from a negative-output diode detector, at the leveling point, to the instrument's ALC IN BNC connector on the front panel. To obtain calibrated leveled power, the EXT CAL adjustment should be made. (See <b>EXT CAL</b> .) The EXT ALC LED is turned on. The displayed message is <code>ALC=Diode</code> . |
| Power Meter Leveling    | The ALC signal is coming from an external power meter. This mode requires an external feedback connection from the recorder output of a power meter, at the leveling point, to the instrument's ALC IN BNC connector on the   |

front panel. To obtain calibrated leveled power, the EXT CAL adjustment should be made. (See **EXT CAL**.) The EXT ALC LED is turned on. The displayed message is: ALC=Power Meter.

**Source Module Leveling** The ALC point is inside an external source module (millimeter head). The displayed message is ALC=SourceModule. This mode is selected automatically when the **(PRESET)** key is pressed with a millimeter head connected.

#### Associated **SCPI** Commands

<b>POWER:ALC:SOURce INTERNAL</b>	<i>Sets the ALC mode to internal.</i>
<b>POWER:ALC[:STATe] ON</b>	<i>Turns ALC on.</i>
<b>POWER:ALC:SOURce DIODE</b>	<i>Sets the ALC source selection switch to external detector leveling.</i>
<b>POWER:ALC:SOURce PMETER</b>	<i>Sets the ALC source selection switch to external power meter leveling.</i>
<b>POWER:ALC:SOURce MMHead</b>	<i>Sets the ALC source selection switch to external millimeter head leveling.</i>
<b>POWER:ALC[:STATe] OFF</b>	<i>Selects unleveled mode.</i>

#### Associated 8350 Commands

<b>A1</b>	<i>Sets ALC mode to internal.</i>
<b>A2</b>	<i>Sets ALC mode to external detector leveling.</i>
<b>A3</b>	<i>Sets ALC mode to external power meter leveling.</i>

**EXT CAL** This function (selected by pressing **(SHIFT) (ALC MODE)**) is used to calibrate the RF output power in external (diode and power meter) leveling modes *only*, by setting a nominal coupling factor between the RF output and the external detector. This coupling factor can be adjusted to make the nominal RF output power agree with the POWER display. This function affects only the RF output power, by offsetting the ALC reference voltage; it does not affect the POWER display. When this function is selected, the coupling factor becomes the active parameter displayed in the MARKER/SWEEP/STATUS area of the display. The display format is `CouP Fact= XX. XdB`. A coupling factor between -30 dB and +30 dB can be entered.

#### Associated **SCPI** Commands

`POWER:ALC:CFACTOR<num> [DB]`

*Sets the coupling factor to be used when the external detector or power meter leveling is used.*

**FLTNESS ON/OFF**

This function toggles the user flatness correction on and off. The flatness correction and the FLTNESS ON LED annunciator are alternately turned on and off each time the key is pressed.

Associated **SCPI** Commands

<b>CORRection[:STATe] ON</b>	<i>Turns flatness correction on</i>
<b>CORRection[:STATe] OFF</b>	<i>Turns flatness correction off.</i>

**FLTNESS CAL**

Selecting this function (by pressing **(SHIFT) (FLTNESS ON/OFF)**) initiates a calibration sequence which calibrates the power level at a remote test port, using an external power meter. Power correction values relative to frequency are measured and stored into a user flatness correction array. The MARKER/SWEEP/STATUS display is used to prompt the user. Before pressing this key, the user should refer to the “Creating User Flatness Arrays” chapter in this manual for detailed instructions.

See Also For detailed task information on how to perform a user flatness calibration refer to “Creating a User Flatness Array, ” in Chapter 5 of this manual.



**————** Entry Keys

# Entry Keys

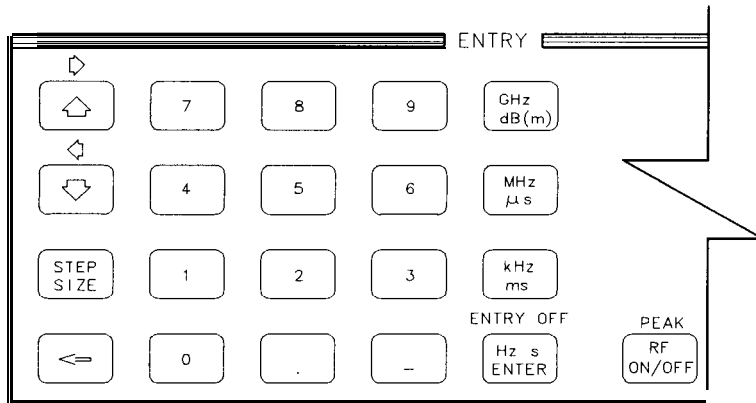

pg4Bob

Figure 14-1. The Entry Group



When one of these keys is pressed, the value of a numeric parameter is increased or decreased by the step size. (See Table 14-1.) If the active parameter selections are non-numeric, or discrete selections, such as On/Off, then the keys will scroll through the available selections.

For frequency and power parameters, the value of the step size can be defined by the user. (See “**STEP SIZE**”.) For other numeric parameters, the step size is fixed, either as a 1, 2, 5 sequence, or a fixed single step-size. For the parameters with a 1, 2, 5 sequence, the first press of the key causes the active parameter to step up or down to a decade multiple of 1, 2, or 5; each subsequent press steps the active parameter to the next higher or lower decade multiple of 1, 2, or 5. The table below lists the numeric parameters in alphabetic order, whether the step size is settable or fixed, and the step size.

Table 14-1. Step Sizes

Numeric Parameter	Fixed/ Settable	Step Size**†	Numeric Parameter	Fixed/ Settable	Step Size**†
Center Frequency	Settable	Frequency Step Size	Power Level	Settable	Power Step Size
c w	Settable	Frequency Step Size	Power Offset	Settable	Power Step Size
Dwell Time	Fixed	1, 2, 5 Sequence	Power Sweep	Settable	Power Step Size
Ext Cal Coup Fact	Settable	Power Step Size	Pulse Period	Fixed	1, 2, 5 Sequence
Frequency Multiplier	Fixed	1	Pulse Width	Fixed	1, 2, 5 Sequence
Frequency Offset	Settable	Frequency Step Size	Slope	Fixed	0.1 dB/GHz
HP-IB Address	Fixed	1‡	Span	Fixed	1, 2, 5 Sequence
Manual Sweep Freq	Settable	Frequency Step Size	Start Frequency	Settable	Frequency Step Size
Marker Δ Ref	Fixed	1	Stop Frequency	Settable	Frequency Step Size
Marker Frequency	Settable	Frequency Step Size	Sweep Time	Fixed	1, 2, 5 Sequence
Points	Fixed	1, 2, 5 Sequence			

\* If the Step Size for a particular parameter reads “Frequency Step Size,” then the parameter will be stepped up or down with the arrow keys by whatever amount the frequency step size has been set to using the **STEP SIZE** key. (This value is 100 MHz at factory preset).



† If the Step Size for a particular parameter reads “Power Step Size,” then the parameter will be stepped up or down with the arrow keys by whatever amount the power step size has been set to using the **STEP SIZE** key. (This value is 1 dB at factory preset.)

‡ Addresses set from the front panel may or may not be retained after a line power cycle, depending on how the rear panel address switch is set. Refer to the “Front/Rear Panel” chapter for information on setting this switch.

**STEP SIZE**

When this key is pressed, the value of the frequency or power step size becomes the active parameter and is shown in the MARKER/SWEEP/STATUS display. Frequency or power is displayed depending on whether a key in the FREQUENCY or the POWER area was last pressed. If the active parameter is not a frequency or power parameter, the display will read:

**\*\*No Step Size\*\***

The display format is **Step=<number><units>**, where **<units>** identifies both the type and magnitude of the step. For frequency step size, the possible units are Hz, kHz, MHz, and GHz. For power step size the only possible unit is dB. If the   keys are used while step size is the active parameter, the step size will be increased or decreased in a 1, 2, 5 sequence.

**Associated SCPI Commands**

<b>FREQUENCY:STEP[:INCRement]</b> <b>&lt;num&gt;[suffix]</b>	<i>Sets the frequency step size to be used for frequency parameters (except SPAN). Setting this value causes <b>FREQ:STEP:AUTO OFF</b></i>
<b>POWER:STEP[: INCRement]</b> <b>&lt;num&gt;[DB]</b>	<i>Sets the power step size to be used for power parameters. Setting this value causes <b>POWER:STEP:AUTO OFF</b></i>

---

## Number Pad Keys

The number pad comprises the digit keys 0 through 9, the decimal point ., the negative sign (-), and the backspace I-). When building a number, the backspace key removes the last character in the string. The negative sign, when legal, toggles the sign of the number being entered.

### NOTE

When numeric keys are pressed, the display shows the new value of the active parameter as it is being entered, however the units are not displayed, and the actual parameter value is not updated until a unit key or the Hz/s/ENTER key is pressed.

---

## Unit Keys

The unit keys serve as terminators for active parameter values being entered from the keypad. They consist of **GHz** (also used for dBm and dB), **MHz** (also used for  $\mu\text{s}$ ), **kHz** (also used for ms), and **Hz/s/ENTER** (used for Hz, V, s, and unitless values).

---

**RF ON/OFF**

Pressing this key toggles the RF output state. If the output is off, the RF OFF annunciator in the right-hand display is turned on.



**Associated SCPI Commands**

POWER:STATE	ON	<i>Turns RF on.</i>
POWER:STATE	OFF	<i>Turns RF off.</i>

**Associated 8350 Commands**

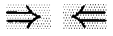
<b>RF1</b>	<i>Turns RF on.</i>
<b>RFO</b>	<i>Turns RF off.</i>



These functions (selected by pressing the (SHIFT) key, and then the  or  key) are only used for certain service related procedures. They are not used during normal front panel operation.



---

## ENTRY OFF

When this function is selected (by pressing (SHIFT) **Hz/s/ENTER**) the active parameter is de-activated, and the MARKER/SWEEP/STATUS display is blanked. All keys in the Entry area are disabled (except for **RF ON/OFF**), including the numeric pad, the **↑** **↓** **STEP SIZE** keys, and the front panel knob. When another key is pressed, that function becomes the active parameter and the Entry area is enabled.

---

**PEAK**

When this function is selected (by pressing **SHIFT** **RF ON/OFF**) the instrument initiates a peaking algorithm which automatically aligns the YIG tracking filter at a series of frequencies over its entire range to optimize RF output power. This procedure is also called autotracking.

Before performing autotracking, make sure the RF OUTPUT is either connected in a 50  $\Omega$  system, or has a load on it, such as a power sensor or attenuator.

---

**CAUTION**

For optimum power at *all* frequencies, do not run peak power-tracking with a millimeter head connected to the sweeper.

While the peaking is in progress, the message `Tracking xx.xx GHz` will be displayed in the MARKER/SWEEP/STATUS area. Note that autotracking will take typically a minute or longer to complete. Pressing the **PRESET** key will abort the autotracking procedure.

**Associated SCPI Commands**`CALibration:PEAKing[:EXEcute]``CALibration:TRACk`

**————** Special Functions

---

# Special Functions

The special functions menu is accessed by selecting **SHIFT** **SPECIAL** in the Instrument State group. See Figure 15-1.

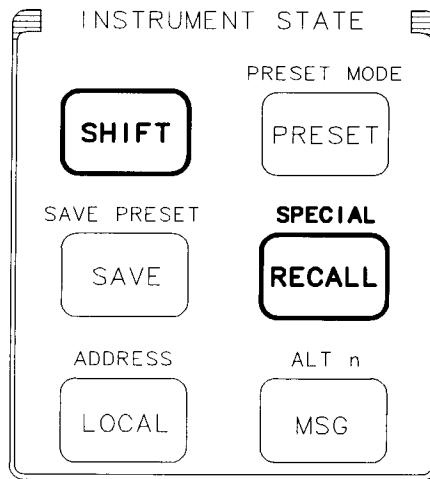

pg41ab



**Figure 15-1. The Instrument Group**

This chapter contains information on the various special functions available for the instrument. Special functions are not available during normal operation, and can only be invoked by selecting the **SPECIAL** function.

When **SPECIAL** is selected, the last-used special function is displayed in the form <number> <function>, such as 8 ROOSC AUTO. A particular special function can be accessed in two ways:

- By scrolling through the special functions menu with the **↑** **↓** keys or the front panel knob until the desired function is displayed and then pressing **Hz/s/ENTER**,

- *OR* by using the keypad to enter the number of the desired function and then pressing Hz/s/ENTER.

Once the Hz/s/ENTER key has been pressed, the selected special function becomes the active parameter in the MARKER/SWEEP/STATUS display. If the special function's selections consist of discrete states (i.e. On/Off or Int/Ext/None), then the   keys or the front panel knob must be used to select the desired state. If the special function is a numerical value, then the keypad may also be used to enter the value. If the keypad is used to enter a value, the value must be terminated with one of the units keys.

Pressing the  key after a parameter has been viewed or changed, returns you to the main menu and you can then scroll through the special functions or enter another special function number.

The special functions in this chapter are organized numerically. See Table 15-1 for a numerical listing of the functions.

Table 15-1. Special Functions for the HP 83750 Series Sweepers

Special Function Number	Function Description	Display (After pressing <u>Hz/s/ENTER</u> )	Value	Factory Preset Condition
1	CWCF AUTO	CW/CF Auto=	On/Off	On
2	CW PEAKNG*	** Peak ing **		
3	SWPTIME AUTO	Time Auto =	On/Off	On
4	STEP SWPTIME	StpSwpTime=	Numerical	401 ms
5	SWPTIME LLIM	TimeLoLim=	Numerical	10 ms
6	ALL COUPLING <sup>†</sup>	Atten Auto=	On/Off	On <sup>†</sup>
7	ATT SETTING <sup>†</sup>	ATTValue=	Numerical	0 dB
8	ROSC AUTO	Rosc Auto=	On/Off	On
9	ROSC SOURCE	Rosc Src=	Int/Ext/None	None <sup>†</sup> or Int <sup>#</sup>
10	V/GHz SCALE	Scale=	Numerical	0.50V/GHz
11	V/GHz OFFSET	Offset=	Numerical	0.00V
12	PWR METER TYPE	Pow Meter=	437B/438A/SCPI/70100A	437B**
13	PWR METER ADDR	Meter Address=	Numerical	13**
14	FM SENSITVY	FM=	-20/-6 <sup>††</sup>	-20 MHz/Volt
15	LANGUAGE	Remote Lang=	SCPI/8350	SCPI <sup>††</sup>
16	FW REVISION	FW Rev =	Numerical	Info only; cannot be changed.
17	SECURITY	(menu)		
18	DP DEFIN	Decimal Point=	. / ,	.**
19	CONTROL MODE	CntrlMode=	Master/Slave	Master
20	Not in use			
21	FULL SELFTST	Current test results	status	Not Run
22	SERVICE##	(menu)		
23	CALIBRATION##	(menu)		
24	DIAGNOSTICS##	(menu)		

The footnotes for Table 15-1 are listed on the following page.

- . This function only works in CW or manual sweep mode.
  - † This special function only operates with sweepers that have Option 1E1.
  - ‡ For instruments without Option 1E5.
  - # For instruments with Option 1E5.
  - \*\* This is the value set when shipped from the factory. If changed, it will not be altered by presetting or cycling the line power on the instrument.
  - †† The selected value will be different than the displayed value if you have a millimeter source module connected to your sweeper. See "FM SENSITIVITY" later in this chapter.
  - ‡‡ This is the value set when shipped from the factory. Changes made via this special function will be retained through an instrument preset. Changes made via this special function may or may not be retained through a cycling of the line power, depending on how the rear panel language switch is set. Refer to the chapter entitled "front/Rear Panel" in this manual for switch setting information.
- ## These special functions provide access to the service related function menus and are documented in the HP *83751A/B and HP 83752A/B Synthesized Sweepers Service Guide*. These areas are intended only for use by service personnel.

---

## 1 - CWCF AUTO

This special function sets the CW/CF coupling to either on or off. When this switch is on, the CW function is coupled to the center frequency, and any change made to the center frequency is also made to CW. However, if CW is changed, the switch is automatically toggled off, and no change is made to the center frequency.

### Associated **SCPI** Commands

<b>:FREQuency[:CW]:AUTO ON</b>	<i>Turns CW/CF coupling on.</i>
<b>:FREQuency[:CW]:AUTO OFF</b>	<i>Turns CW/CF coupling off.</i>



## 2 - CW PEAKNG

This function causes a one-time execution of the peaking function when the sweeper is in CW or manual sweep mode. It aligns the output filter so that its passband is centered on the RF output.

CW peaking is used to obtain the maximum available power and spectral purity, and the best pulse and FM envelopes at a given frequency.

### NOTE

If the instrument is not in CW or manual sweep mode, nothing will happen when **Hz/s/ENTER** is pressed.

### Associated **SCPI** Commands

**CALibration:PEAKing[:EXECute]**      *Executes the peaking function.*

---

### 3 - SWPTIME AUTO

This function lets you set the instrument's sweep tune to a minimum value for a chosen span and meet all specifications. The sweep tune is limited by a 400 MHz/ms sweep rate.

When sweep time auto is "on," the fastest sweep tune allowed for the frequency span swept is automatically selected. When sweep time auto is "off," changing frequency span does not change the sweep time.

#### Associated **SCPI** Commands

SWEep:TIME:AUTO	ON	<i>Turns on sweep time Auto.</i>
SWEep:TIME:AUTO	OFF	<i>Turns off sweep time Auto.</i>

---

## 4 - STEP SWPTIME

This function is used to set the sweep time while in stepped sweep mode. The stepped sweep time can only be changed while the sweeper is in stepped sweep mode. The front panel **TIME** key which is normally used to set sweep time while in analog sweep mode, will display the dwell time if pressed while in stepped sweep mode. The stepped sweep time is coupled with Dwell Time and Points by the equation:

$$\text{Step sweep time} = (\text{Dwell Time}) * (\text{Points})$$

Note that the equation does not include frequency switching time.

As stepped sweep time is adjusted, dwell time will be adjusted proportionately. At factory preset, the dwell time is set to its minimum setting of 1 ms. Therefore, the stepped sweep time cannot be decreased from its factory preset value unless the number of points is decreased.

### NOTE

If stepped sweep time is adjusted to an invalid sweep time, the stepped sweep time value will snap to the nearest legal value and instrument error -222 (limit error) may occur.

**5 - SWPTIME  
LLIM**

This function allows you to set the lower limit of the sweep time. The lower limit refers to the fastest sweep rate that the instrument will sweep. Performing a preset removes the limit and allows the instrument to sweep at the fastest possible rate.

---

## 6 - ATT COUPLING

This function allows you to set the RF attenuator coupling switch. When the switch is on, internal algorithms select the proper attenuator setting for optimum ALC performance.

When the attenuator coupling is turned off, the attenuator setting is set to the whatever the current value is and left there. When the coupling is off, the UNCLPD annunciator appears in the right-hand display. If ATT SETTING (special function number 7) is used to set a specific attenuation, the RF attenuator coupling switch is automatically turned off.

### NOTE

Since this function applies only to Internal or Uneveled ALC modes, the UNCLPD annunciator will light in external ALC mode operation regardless of how the attenuator coupling switch is set.

### NOTE

This function is visible with all instruments, but only active in instruments with Option 1E1.

### Associated SCPI Commands

POWER:ATTenuation:AUTO ON	<i>Turns the RF attenuator coupling switch on.</i>
POWER:ATTenuation:AUTO OFF	<i>Turns the RF attenuator coupling switch off.</i>

---

## 7 - ATT SETTING

This function sets the output attenuation level. Note that when setting the attenuator level to 10 dB, the output power will be decreased by 10 dB. Setting a specified attenuation turns the RF attenuator coupling switch off.

### NOTE

This function is visible with all instruments, but only active in instruments with Option 1E1.

### Associated **SCPI** Commands

**POWER:ATTenuation:<num>[DB]**

*Sets the RF attenuator to the desired attenuation.*

---

## 8 - ROSC AUTO

This function sets the automatic reference oscillator selection switch. When this switch is on, the instrument automatically selects the frequency standard to be used.

When the selection switch is on, the instrument will automatically select an external standard if one is connected to the rear panel 10 MHz REF IN connector. If there is no external standard connected, the instrument will select the optional internal standard (Option 1E5), if so equipped. Or if there is no internal standard, the internal 100 MHz VCXO will operate in a free-run mode.

If ROSC SOURCE (special function number 9) is used to set the reference to a specific reference, the automatic reference selection switch will be turned off.

### Associated **SCPI** Commands

<code>ROSCillator:SOURCE:AUTO ON</code>	<i>Turns the automatic reference selection switch on.</i>
<code>ROSCillator:SOURCE:AUTO OFF</code>	<i>Turns the automatic reference selection switch off.</i>

---

## 9 - ROSC SOURCE

This function allows you to set the frequency standard to be used by the sweeper. When this function is used to select the frequency standard, the automatic reference selection switch will be turned off. The three frequency standard selections are:

INT	Sets the sweeper to use its internal frequency standard as its reference.
EXT	Sets the sweeper to accept an external frequency standard as its reference.
NONE	Sets the sweeper to free-run operation, where no frequency standard is used.

### NOTE

Selecting **INT** on an instrument without Option 1E5, or **EXT** without an external reference connected, can cause poor frequency accuracy and synthesizer unlocks.

### Associated **SCPI** Commands

<b>ROSCillator:SOURCE INTernal</b>	<i>Sets the frequency standard to internal.</i>
<b>ROSCillator:SOURCE EXTernal</b>	<i>Sets the frequency standard to external.</i>
<b>ROSCillator:SOURCE NONE</b>	<i>Sets the frequency standard to none.</i>



---

## 10 - V/GHz SCALE

This function allows you to scale the V/GHz voltage at the rear panel VOLTS/GHZ OUTPUT connector to the desired value. The acceptable range of values for this function is -10.00 V/GHz to + 10.00 V/GHz, with 0.50 V/GHz being the factory preset value. The rear panel output is limited to a  $\pm 12$  V range.

### Associated **SCPI** Commands

CORRection:VOLTS:SCALE <num>      *Sets the V/GHz scale to the desired value.*

---

## 11 - V/GHz OFFSET

This function allows you to offset the VOLTS/GHZ OUTPUT on the rear panel. The acceptable range of values for this function is  $-10$  to  $+10$  V, with the factory preset value being 0.00 V. The rear panel output is limited to a  $\pm 12$  V range.

### Associated **SCPI** Commands

CORRection:VOLTs:OFFSet <num>      *Sets the V/GHz offset to the desired value.*

---

## 12 - PWR METER TY

This function allows you to select the type of power meter that the sweeper can control via HP-IB to calibrate user flatness. The choices are:

437B  
438A  
SCPI  
70100A

### NOTE

The default power meter selection from the factory is 437B. If you change to another selection, it will not be altered, or reset to 437B by presetting or cycling the line power on the instrument.

### Associated **SCPI** Commands

SYSTEM:COMMunicate:PMETer:TYPE

*Sets the type of power meter expected over the HP-IB to be used for the power meter during sweeper calibration routines.*

---

## 13 - PWR METER AD

This function allows you to set the power meter HP-IB address to the desired setting. The range of acceptable values is from 0 to 30.

### NOTE

The value set at the factory is 13. If you change this value, it will not be altered, or reset to 13, by presetting or cycling the line power on the instrument.

### Associated **SCPI** Commands

SYSTem:COMMunicate:PMETer:ADDRESS

*Sets the HP-IB address to used for the power meter during sweeper calibration routines.*

## 14 - FM SENSITIVITY

This function allows you to choose the FM sensitivity of your instrument: either -6 MHz/V or -20 MHz/V. The factory preset default value is -20 MHz/V

### NOTE

The FM sensitivity will change from the nominal -6 or -20 MHz/V when a millimeter source module is connected to the sweeper. Refer to the table below for the actual FM sensitivity respective to the source module used.

Table 15-2. FM Sensitivity When Using Source Modules

Source Module	Actual FM Sensitivity When Sweeper is Set to:	
	- 6 MHz/Volt	- 20 MHz/Volt
HP 83554 (x2)	- 1.2 MHz/V	- 4.0 MHz/V
HP 83555 (x3)	- 1.8 MHz/V	- 6.0 MHz/V
HP 83556 (x3)	- 1.8 MHz/V	- 6.0 MHz/V
HP 83557 (x4)	- 2.4 MHz/V	- 8.0 MHz/V
HP 83558 (x6)	- 3.6 MHz/V	- 12.0 MHz/V

### Associated SCPI Commands

<b>FM:SENSitivity</b> -6 MHz/V	<i>Sets the FM sensitivity to -6 MHz/V.</i>
<b>FM:SENSitivity</b> -20 MHz/V	<i>Sets the FM sensitivity to -20 MHz/V.</i>

---

## 15 - LANGUAGE

This function allows you to select the instrument programming language: either SCPI or HP 8350 compatible.

**NOTE**

Your language selection may or may not be retained if line power to the instrument is lost, depending upon the rear-panel language selection switch. For information on setting the rear panel switch refer to the "HP-IB Switch" section of Chapter 7 in this manual, *or* refer to the *Installation and Quick Start Guide* for more detailed instructions on setting this switch.

**Associated SCPI Commands**

SYStem:LANGuage	SCPI	<i>Sets the instrument programming language to SCPI.</i>
SYStem:LANGuage	COMP	<i>Sets the instrument programming language to HP 8350 compatible.</i>

---

## 16 - **FW** REVISION

This function allows you to view the revision number of the firmware that is installed in your instrument.

### Associated **SCPI** Commands

\*IDN?

*Queries the instrument for model number, serial number, and firmware revision.*

---

## 17 - \*SECURITY

The \*SECURITY selection is a menu of functions that provide you with the following capabilities:

- Replacing the frequency and marker displays with zeros.
- Clearing and initializing RAMs to zeros.
- Disabling the **SAVE** function.
- Blanking the display.
- Locking the front panel keyboard.

When you press **SHIFT** **SPECIAL** **17** (Hz/s/ENTER\_) the security menu is displayed. The following are descriptions of each of the menu items:

**400 ZERO  
FREQ** This function allows you to replace the frequency and markers displayed on the front panel with zeros. Each frequency is displayed as 0.00000000Hz. If markers have been set, they are also displayed as zeros. Annunciators, such as SWEEP and CW, are *not* blanked.

This function cannot be executed when the instrument is connected to an HP 8757 or when the instrument is speaking 8350 compatibility language. If you attempt to do so, nothing happens except an error message is displayed.

When you press **SHIFT** **SPECIAL** **400** **Hz/s/ENTER** , the following message is displayed: ZERO Frq?y/ENTER.

- If you do not want the frequencies zeroed, press **←**. This key takes you back one level to the 400 ZERO FREQ selection.
- If you do want all of the displayed frequencies to be set to 0.00000000 Hz, press **Hz/s/ENTER**.

To return the display to show frequencies, either press **PRESET** or cycle the power.

### Associated **SCPI** Commands

SYSTem:SECurity:ZERO ON	<i>Sets the frequency to zeros.</i>
SYSTem:SECurity:ZERO OFF	<i>Sets the instrument to display frequenq</i>



**401 CLEAR MEMORY** This function lets you clear and initialize the entire content of RAM to all zeros. This clears all of the save/recall registers. The number of times that memory is cleared and the RAMs are set to zeros is set by 482 CLRMEM COUNT. After the RAMs are cleared, the instrument is set to preset conditions.

When you press **SHIFT** **SPECIAL** **401** [Hz/s/ENTER), the following message is displayed: C l r mem? y/ENTER.

- If you do not want the save/recall registers cleared, press **←**. The message **Memory Not Clear** appears briefly and you are returned to the **401 CLEAR MEMORY** selection.
- If do want all of the save/recall registers to be cleared by initializing the RAMs to all zeros, press (Hz/s/ENTER).

#### Associated **SCPI** Commands

**SYSTEM:SECURITY:CLEAR**

*Sets the RAMs to zeros and presets the instrument.*

**MEMORY:RAM:INITIALIZE[:ALL]**

*Sets the RAMs to zeros and presets the instrument.*

402 **CLRMEM** This function lets you set the number of times that the RAMs will be cleared  
**COUNT** and initialized to zeros with the clear memory function.

When you press **(SHIFT)**, **SPECIAL** **(402)** **(Hz/s/ENTER\_)**, the following message is displayed: `CLRMEM COUNT= 1`. The **(↑)** **(↓)** keys or the front panel knob let you change the count. Or use the numeric keypad to enter the new value. Numbers between and including 1 through 20 are accepted.

The clear memory count is reset to a value of one at preset or when power is cycled on the instrument.

**Associated SCPI Commands**

`SYSTEM:SECURITY:COUNT <num> [MIN] [MAX]` *Sets the number of times that RAMs are initialized to zeros.*

403 **SAVE** This function allows you to enable or disable the **(SAVE)** function. When the  
**LOCK** function is enabled, you can save instrument states into the nine available registers using the **(SAVE)** key. When the function is disabled, you cannot save instrument states, and the message `SAVE LOCKED !!` will appear in the `MARKER/SWEEP/STATUS` display if you attempt to do so.

When your instrument was shipped, the save function was enabled.

When you press **(SHIFT)** **SPECIAL** **(403)** **(Hz/s/ENTER\_)**, the following message is displayed: `SAVEKEY=Enabled`. The **(↑)** **(↓)** keys or the front panel knob let you toggle between enabled and disabled.

If you disable this function, it will stay disabled (through presets and power cycles) until you enable it again using this special function.

**Associated SCPI Commands**

`SYSTEM:KEY:ENABLE SAVE` *Enables the [[SAVE]] key.*  
`SYSTEM:KEY:DISABLE SAVE` *Disables the [[SAVE]] key.*

404 BLANK This function allows you to turn the display off.

DISPLY When you press **(SHIFT)** SPECIAL **(404)** **(HZ/S/ENTER)** , the following message is displayed: `DiSP lEy i s ON`. The **(↑)** **(↓)** keys or the front panel knob let you toggle from a normal display to a blanked display. When you blank the display, the message `DISPLAy BLANKED` appears in the frequency display.

To turn the display mode back on, press **(PRESET)**.

Associated **SCPI** Commands

<code>DISPlay[:STATe] OFF</code>	<i>Turns the display off.</i>
<code>DISPlay[:STATe] ON</code>	<i>Turns the display on.</i>
<code>SYSTem:PRESet[:EXECute]</code>	<i>Presets the sweeper and turns the display on.</i>

405 SYSTEM This function allows you to lock the front panel keyboard

KLOCK When you press **(SHIFT)** SPECIAL **(405)** **(HZ/S/ENTER)** , the following message is displayed: `KeyBrd Lock=OFF`. The **(↑)** **(↓)** keys or the front panel knob let you toggle from a normal keyboard to a locked keyboard. When you lock the keyboard, it is locked against any entry except for preset and cycling power. If you press any other key, nothing happens except the message `Press PRESET to proceed!` is displayed.

To unlock the keyboard, either press **(PRESET)** or cycle power.

Associated **SCPI** Commands

<code>SYSTem:SECurity:KLOCK ON</code>	<i>Locks the front panel keyboard.</i>
<code>SYSTem:SECurity:KLOCK OFF</code>	<i>Unlocks the front panel keyboard.</i>
<code>SYSTem:PRESet[:EXECute]</code>	<i>Unlocks the front panel and presets the sweeper.</i>

---

**18 - DP  
DEFIN**

This function allows you to select whether the decimal point appears as a period, or as a comma.

**Associated SCPI Commands**

None.

---

## 19 - CONTROL MODE

This function allows you to set your sweeper to either the master or slave state. For more information on master/slave operation, refer to Chapter 6, “Operating a Master/Slave Setup.”

### Associated **SCPI** Commands

SWEep:CONTrol:TYPE **MASTeR**

*Sets the sweeper to the master state.*

SWEep:CONTrol:TYPE **SLAVe**

*Sets the sweeper to the slave state.*

---

## 21 - FULL SELFTST

This function displays the results of the last time the self-test was run, or displays `NOTRUN` if the test has not been run since the last time power was turned on.

Pressing the Hz/S/ENTER key will activate the self-test. All external cables must be disconnected prior to running the self-test. While the test is being performed a `*** wait ***` message will appear in the right-hand display, and when the test is done, the results will be displayed. If the self-test passed, the results will read, `Full Test . PASSED`. If there is a failure, the test that failed will appear in the `MARKER/SWEEP/STATUS` display, preceded by `-->`. If more than one test failed, the most significant failure will be displayed.

Before sweeper operation can be continued, a preset must be performed.

If the self-test fails (does not say `FullTest PASSED`), refer to the “Troubleshooting” chapter of the *Service Guide*.

### Associated **SCPI** Commands

<code>*TST</code>	<i>Performs a full self-test</i>
<code>DIAGnostic:TEST:FULLtest?</code>	<i>Executes the full self-test.</i>
<code>DIAGnostic:TEST:FULLtest:REPort?</code>	<i>This query command will return a single test and its data. This test is the most probable failure test in the following format: &lt;name&gt; &lt;status&gt; &lt;minValue&gt; &lt;actualData&gt; &lt;maxValue&gt;.</i>

**————** Error Messages

---

# Error Messages

If an error condition occurs in the sweeper, it will always be reported to both the front panel and HP-IB error queues. These two queues are viewed and managed separately. The **MSG** key is used to view the contents of the front panel error queue. The HP-IB query "SYSTEM:ERRor?" is used to view the contents of the HP-IB error queue.

If there are any error messages in the front panel error queue, the front panel MSG annunciator will be lit. Pressing the **MSG** key repeatedly until the MSG annunciator turns off will empty the front panel error queue. The **MSG** key has no effect on the HP-IB error queue. Emptying the HP-IB error queue has no effect on the front panel queue, therefore, it will not affect the MSG annunciator.

There are some special error types that are called permanent errors. Permanent errors remain in the error queues until the error condition is cleared. Pressing the **MSG** key will empty the front panel error queue, but the permanent errors will be re-reported if the error conditions still exist. In the HP-IB error queue, the permanent errors are re-reported after the message, 0, "No error" is read using the "SYSTEM:ERRor?" query or after the "\*CLS" command is executed.



---

# The Error/Event Queue

As errors and events are detected, they are placed in a queue. This queue is First in, First out. If the queue overflows, the last error/event in the queue is replaced with error

-350 "Queue overflow"

Any time the queue overflows, the least recent errors remain in the queue, and the most recent error/event is discarded. The minimum length of the error/event queue is 2, one position for the first error, and one for the "Queue overflow" message. Reading an error/event from the head of the queue removes that error/event from the queue, and opens a position at the tail of the queue for a new error/event, if one is subsequently detected.

When all errors/events have been read from the queue, further error/event queries shall return

0, "No error"

Individual errors and events may be enabled into the queue. The `STATUS:QUEUE:ENABLE` command accomplishes this. At `STATUS:PRESet`, only errors are enabled. This means that both `SYSTEM:ERROR?` and `STATUS:QUEUE[:NEXT]?` report only errors unless the user changes the enable mask.

The error/event queue shall be cleared when any of the following occur (IEEE 488.2, section 11.4.3.4):

- Upon power up
- Upon receipt of a `*CLS` command
- Upon reading the last item from the queue

---

## Error numbers

The system-defined error/event numbers are chosen on an enumerated (“1 of N”) basis. The SCPI-defined error/event numbers and the <error description> portions of the ERRor query response are listed here. The first error/event described in each class (for example, -100, -200, -300, -400) is a “generic” error. In selecting the proper Error/event number to report, more specific error/event codes are preferred, and the generic error/event is used only if the others are inappropriate.

---

# Error Messages List

The list of error messages in this chapter lists all of the error messages associated with sweeper operation. An example of the error format found in the list of error messages is as follows:

403    **-222, "Data out of range;Test Patch Value Out of Range(403)"**

Indicates that user has entered a Self-Test Patch with upper or lower limit values greater than allowed. All upper and lower limits of these Self-Test Patches must be within the range of +32767 to -32768.

The following explains each element of an error message listing

- **Manual Error Number** – The number 403 to the left and in the parenthesis is called the Manual Error Number. The error ‘message list is organized in ascending order off the manual error number. The manual error number will always be found in the parenthesis contained in the message.
- **Error Message** – The bold text **-222, “Data out of range;Test Patch Value Out of Range”** is the error message. When the **MSG** key is pressed, the error message is displayed in the leftmost display. The entire message is returned by the HP-IB query “SYSTem:ERRor?”. The error message contains the following parts:
  - **SCPI Error Number** – The standard SCPI error number (-222 in the example) usually differs from the manual error number because the manual error number is unique for every possible message. Standard SCPI error numbers are always negative (except for 0, “No error”). If there is no standard SCPI error number for a message, the manual error number replaces it in the error message.
  - **SCPI Error Message** – The SCPI error message is Data out of range in the example.
  - **Detailed Description** – All information after the semicolon (;) is a detailed description of what exactly caused the error. In the example, Test Patch Value Out of Range tells you that the user has entered a Self-Test Patch with upper or lower limit values greater than allowed. If no detailed description exists, it will be omitted from the message.

- Action Required – The text that appears below each error message listing contains corrective actions that should be followed in order to correct the error condition.

Note that the action required is never shown in the sweeper display.

---

## Command Error

An <error/event number> in the range [ -199, -100 ] indicates that an IEEE 488.2 syntax error has been detected by the instrument's parser. The occurrence of any error in this class shall cause the command error bit (bit 5) in the event status register (IEEE 488.2, section 11.5.1) to be set. One of the following events has occurred:

- An IEEE 488.2 syntax error has been detected by the parser. That is, a controller-to-device message was received which is in violation of the IEEE 488.2 standard. Possible violations include a data element which violates the device listening formats or whose type is unacceptable to the device.
- An unrecognized header was received. Unrecognized headers include incorrect device-specific headers and incorrect or unimplemented IEEE 488.2 common commands.
- A Group Execute Trigger (GET) was entered into the input buffer inside of an IEEE 488.2 <PROGRAM MESSAGE>.

Events that generate command errors shall not generate execution errors, device-specific errors, or query errors; see the other error definitions in this chapter.

**SCPI Error Messages**

Error Number	Error Description [description/explanation/examples]
-100	<p>“Command error”</p> <p>This is the generic syntax error for devices that cannot detect more specific errors. This code indicates only that a Command Error as defined in IEEE 488.2, 11.5.1.1.4 has occurred.</p>
-101	<p>“Invalid character”</p> <p>A syntactic element contains a character which is invalid for that type; for example, a header containing an ampersand, SETUP&amp;. This error might be used in place of errors -114, -121, -141, and perhaps some others.</p>
-102	<p>“Syntax error”</p> <p>An unrecognized command or data type was encountered; for example, a string was received when the device does not accept strings.</p>
-103	<p>“Invalid separator”</p> <p>The parser was expecting a separator and encountered an illegal character; for example, the semicolon was omitted after a program message unit, *EMC 1 :CHI:VoLTS 5.</p>
-104	<p>“Data type error”</p> <p>The parser recognized a data element different than one allowed; for example, numeric or string data was expected but block data was encountered.</p>
-105	<p>“GET not allowed”</p> <p>A Group Execute Trigger was received within a program message. (See IEEE 488.2, 7.7). Correct the HP-IB controller program so that the group execute trigger does not occur within a line of HP-IB program code.</p>
-108	<p>“Parameter not allowed”</p> <p>More parameters were received than expected for the header; for example, the *EMC common command only accepts one parameter, so receiving *EMC 0,1 is not allowed.</p>

- 109 “Missing parameter”  
Fewer parameters were received than required for the header; for example, the \*EMC common command requires one parameter, so receiving \*EMC is not allowed.
- 110 “Command header error”  
An error was detected in the header. This error message should be used when the device cannot detect the more specific errors described for errors – 111 through – 119.
- 111 “Header separator error”  
A character which is not a legal header separator was encountered while parsing the header; for example, no white space followed the header, thus \*GMC“MACRO” is an error.
- 112 “Program mnemonic too long”  
The header contains more than twelve characters. (See IEEE 488.2, 7.6.1.4.1).
- 113 “Undefined header”  
The header is syntactically correct, but it is undefined for this specific device; for example, \*XYZ is not defined for any device.
- 114 “Header suffix out of range”  
The value of a numeric suffix attached to a program mnemonic makes the header invalid.
- 120 “Numeric data error”  
This error, as well as errors -121 through -129, are generated when parsing a data element which appears to be numeric, including the nondecimal numeric types. This particular error message should be used if the device cannot detect a more specific error.
- 121 “Invalid character in number”  
An invalid character for the data type being parsed was encountered; for example, an alpha in a decimal numeric or a “9” in octal data.

**SCPI Error Messages**

- 123      “Exponent too large”  
The magnitude of the exponent was larger than 32000. (See IEEE 488.2, 7.7.2.4.1).
- 124      “Too many digits”  
The mantissa of a decimal numeric data element contained more than 255 digits excluding leading zeros. (See IEEE 488.2, 7.7.2.4.1).
- 128      “Numeric data not allowed”  
A legal numeric data element was received, but the device does not accept one in this position for the header.
- 130      “Suffix error”  
This error, as well as errors – 131 through – 139, are generated when parsing a suffix. This particular error message should be used if the device cannot detect a more specific error.
- 131      “Invalid suffix”  
The suffix does not follow the syntax described in IEEE 488.2, 7.7.3.2, or the suffix is inappropriate for this device.
- 134      “Suffix too long”  
The suffix contained more than 12 characters. (See IEEE 488.2, 7.7.3.4).
- 138      “Suffix not allowed”  
A suffix was encountered after a numeric element which does not allow suffixes.
- 140      “Character data error”  
This error, as well as errors -141 through -149, are generated when parsing a character data element. This particular error message should be used if the device cannot detect a more specific error.
- 141      “Invalid character data”  
Either the character data element contains an invalid character or the particular element received is not valid for the header.



- 144      “Character data too long”  
The character data element contains more than twelve characters.  
(See IEEE 488.2, 7.7.1.4).
- 148      “Character data not allowed”  
A legal character data element was encountered where prohibited  
by the device.
- 150      “String data error”  
This error, as well as errors -151 through -159, are generated  
when parsing a string data element. This particular error message  
should be used if the device cannot detect a more specific error.
- 151      “Invalid string data”  
A string data element was expected, but was invalid for some  
reason. (See IEEE 488.2, 7.7.5.2); for example, an END message  
was received before the terminal quote character.
- 158      “String data not allowed”  
A string data element was encountered but was not allowed by the  
device at this point in parsing.
- 160      “Block data error”  
This error, as well as errors -161 through -169, are generated  
when parsing a block data element. This particular error message  
should be used if the device cannot detect a more specific error.
- 161      “Invalid block data”  
A block data element was expected, but was invalid for some  
reason. (See IEEE 488.2, 7.7.6.2); for example, an END message  
was received before the length was satisfied.
- 168      “Block data not allowed”  
A legal block data element was encountered but was not allowed  
by the device at this point in parsing.

**SCPI Error Messages**

- 170      “Expression error”  
This error, as well as errors -171 through -179, are generated when parsing an expression data element. This particular error message should be used if the device cannot detect a more specific error.
- 171      “Invalid expression”  
The expression data element was invalid. (See IEEE 488.2, 7.7.7.2); for example, unmatched parentheses or an illegal character.
- 178      “Expression data not allowed”  
A legal expression data was encountered but was not allowed by the device at this point in parsing.
- 180      “Macro error”  
This error, as well as errors -181 through -189, are generated when defining a macro or executing a macro. This particular error message should be used if the device cannot detect a more specific error.
- 181      “Invalid outside macro definition”  
Indicates that a macro parameter placeholder ( $\$(\text{number})$ ) was encountered outside of a macro definition.
- 183      “Invalid inside macro definition”  
Indicates that the program message unit sequence, sent with a \*DDT or \*DMC command, is syntactically invalid. (See IEEE 488.2, 10.7.6.3).
- 184      “Macro parameter error”  
Indicates that a command inside the macro definition had the wrong number or type of parameters.

---

## Execution Error

An <error/event number> in the range [ -299, -200 ] indicates that an error has been detected by the instrument's execution control block. The occurrence of any error in this class shall cause the execution error bit (bit 4) in the event status register (IEEE 488.2, section 1 I.S. 1) to be set. one of the following events has occurred:

- A <PROGRAM DATA> element following a header was evaluated by the device as outside of its legal input range or is otherwise inconsistent with the device's capabilities.
- A valid program message could not be properly executed due to some device condition.

Execution errors shall be reported by the device after rounding and expression evaluation operations have taken place. Rounding a numeric data element, for example, shall not be reported as an execution error. Events that generate execution errors shall not generate Command Errors, device-specific errors, or Query Errors; see the other error definitions in this section.

**SCPI** Error Messages

Error Number	Error Description [description/explanation/examples]
-200	<p>“Execution error”</p> <p>This is the generic syntax error for devices that cannot detect more specific errors. This code indicates only that an Execution Error as defined in IEEE 488.2, 11.5.1.1.5 has occurred.</p>
-201	<p>“Invalid while in local”</p> <p>Indicates that a command is not executable while the device is in local due to a hard local control. (See IEEE 488.2, 5.6.1.5); for example, a device with a rotary switch receives a message which would change the switches state, but the device is in local so the message cannot be executed.</p>
-202	<p>“Settings lost due to rtl”</p> <p>Indicates that a setting associated with a hard local control. (See IEEE 488.2, 5.6.15); was lost when the device changed to LOCS from REMS or to LWLS from RWLS.</p>
-210	<p>“Trigger error”</p> <p>A trigger error occurred in the signal generator.</p>
-211	<p>“Trigger ignored”</p> <p>Indicates that a GET, *TRG, or triggering signal was received and recognized by the device but was ignored because of device timing considerations; for example, the device was not ready to respond. Note: a DTO device always ignores GET and treats *TRG as a Command Error.</p>
-212	<p>“Arm ignored”</p> <p>Indicates that an arming signal was received and recognized by the device but was ignored.</p>
-213	<p>“Init ignored”</p> <p>Indicates that a request for a measurement initiation was ignored as another measurement was already in progress.</p>

- 214      “Trigger deadlock”  
Indicates that the trigger source for the initiation of a measurement is set to GET and subsequent measurement query is received. The measurement cannot be started until a GET is received, but the GET would cause an INTERRUPTED error.
- 215      “Arm deadlock”  
Indicates that the arm source for the initiation of a measurement is set to GET and subsequent measurement query is received. The measurement cannot be started until a GET is received, but the GET would cause an INTERRUPTED error.
- 220      “Parameter error”  
Indicates that a program data element related error occurred. This error message 0 should be used when the device cannot detect the more specific errors described for errors -221 through -229.
- 221      “Settings conflict”  
Indicates that a legal program data element was parsed but could not be executed due to the current device state. (See IEEE 488.2, 6.4.5.3 and 11.5.1.1.5).
- 222      “Data out of range”  
Indicates that a legal program data element was parsed but could not be executed because the interpreted value was outside the legal range as defined by the device. (See IEEE 488.2, 11.5.1.1.5).
- 223      “Too much data”  
Indicates that a legal program data element of block, expression, or string type was received that contained more data than the device could handle due to memory or related device-specific requirements.
- 224      Illegal parameter value  
Used where exact value, from a list of possibilities, was expected.
- 225      Out of memory.  
The device has insufficient memory to perform the requested operation.

**SCPI Error Messages**

- 226 Lists not same length.  
Attempted to use LIST structure having individual LIST's of unequal lengths.
- 230 Data corrupt or stale  
Possibly invalid data; new reading started but not completed since last access.
- 231 Data questionable  
Indicates that measurement accuracy is suspect.
- 240 Hardware error  
Indicates that a legal program command or query could not be executed because of a hardware problem in the device. Definition of what constitutes a hardware problem is completely device-specific. This error message should be used when the *device* cannot detect the more specific errors described for errors -241 through -249.
- 241 Hardware missing  
Indicates that a legal program command or query could not be executed because of missing *device* hardware; for example, an option was not installed. Definition of what constitutes missing hardware is completely device-specific.
- 260 Expression error  
Indicates that a expression program data element related error occurred. This error message should be used when the device cannot detect the more specific errors described for errors -261 through -269.

- 261      Math error in expression
- Indicates that a syntactically** legal expression program data element could not be executed due to a math error; for example, a divide-by-zero was attempted. The definition of math error is device-specific.
- 270      Macro error
- Indicates that a macro-related execution error occurred. This error message should be used when the device cannot detect the more specific errors described for errors -271 through -279.
- 271      Macro syntax error
- Indicates that a syntactically legal macro program data sequence, according to IEEE 488.2,10.7.2, could not be executed due to a syntax error within the macro definition. (See IEEE 488.2, 10.7.6.3).
- 272      Macro execution error
- Indicates that a syntactically legal macro program data sequence could not be executed due to some error in the macro definition. (See IEEE 488.2, 10.7.6.3).
- 273      Illegal macro label
- Indicates that the macro label defined in the \*DMC command was a legal string syntax, but could not be accepted by the device. (See IEEE 488.2, 10.7.3 and 10.7.6.2); for example, the label was too long, the same as a common command header, or contained invalid header syntax.
- 274      Macro parameter error
- Indicates that the macro definition improperly used a macro parameter placeholder. (See IEEE 488.2,10.7.3).
- 275      Macro definition too long
- Indicates that a syntactically legal macro program data sequence could not be executed because the string or block contents were too long for the device to handle. (See IEEE 488.2, 10.7.6.1).

- 276      Macro recursion error  
Indicates that a syntactically legal macro program data sequence could not be executed because the device found it to be recursive. (See IEEE 488.2, 10.7.6.6).
- 277      Macro redefinition not allowed  
Indicates that a syntactically legal macro label in the \*DMC command could not be executed because the macro label was already defined. (See IEEE 488.2, 10.7.6.4).
- 278      Macro header not found  
Indicates that a syntactically legal macro label in the \*GMC? query could not be executed because the header was not previously defined.



---

## Device-specific Error

An <error/event number> in the range [ -399, -300 ] or [ 1, 32767 ] indicates that the instrument has detected an error which is not a command error, a query error, or an execution error; some device operations did not properly complete, possibly due to an abnormal hardware or firmware condition. These codes are also used for self- test response errors. The occurrence of any error in this class should cause the device-specific error bit (bit 3) in the event status register (IEEE 488.2, section 11.5.1) to be set. The meaning of positive error codes is device-dependent and may be enumerated or bit mapped; the <error message> string for positive error codes

is not defined by SCPI and available to the device designer. Note that the string is not optional; if the designer does not wish to implement a string for a particular error, the null string should be sent (for example, 42," "). The occurrence of any error in this class should cause the device-specific error bit (bit 3) in the event status register (IEEE 488.2, section 11.5.1) to be set. Events that generate device-specific errors shall not generate command errors, execution errors, or query errors; see the other error definitions in this section.

**SCPI** Error Messages

Error Number	Error Description [description/explanation/examples]
-300	Device-specific error  This is the generic device dependent error for devices that cannot detect more specific errors. This code indicates only that a Device-Dependent Error as defined in IEEE 488.2, 11.5.1.1.6 has occurred.
-310	System error  Indicates that some error, termed “system error” by the device, has occurred. This code is device-dependent.
-311	Memory error  Indicates that an error was detected in the device’s memory. The scope of this error is device-dependent.
-314	Save/recall memory lost  Indicates that the nonvolatile data saved by the *SAV? command has been lost.
-315	Configuration memory lost  Indicates that nonvolatile configuration data saved by the device has been lost. The meaning of this error is device-specific.
-330	Self-test failed
-350	Queue overflow  A specific code entered into the queue in lieu of the code that caused the error. This code indicates that there is no room in the queue and an error occurred but was not recorded.

## Query Error

An <error/event number> in the range [ -499, -400] indicates that the output queue control of the instrument has detected a problem with the message exchange protocol described in IEEE 488.2, chapter 6. The occurrence of any error in this class shall cause the query error bit (bit 2) in the event status register (IEEE 488.2, section 11.5.1) to be set. These errors correspond to message exchange protocol errors described in IEEE 488.2, section 6.5. One of the following is true:

- An attempt is being made to read data from the output queue when no output is either present or pending;
- Data in the output queue has been lost.

Events that generate query errors shall not generate command errors, execution errors, or device-specific errors; see the other error definitions in this section.

**SCPI** Error Messages

Error Number	Error Description [description/explanation/examples]
-400	Query error  This is the generic query error for devices that cannot detect more specific errors. This code indicates only that a Query Error as defined in IEEE 488.2, 11.5.1.1.7 and 6.3 has occurred.
-410	Query INTERRUPTED  Indicates that a condition causing an INTERRUPTED Query error occurred. (See IEEE 488.2, 6.3.2.3); for example, a query followed by DAB or GET before a response was completely sent.
-420	Query UNTERMINATED  Indicates that a condition causing an UNTERMINATED Query error occurred. (See IEEE 488.2, 6.3.2.2); for example, the <i>device</i> was addressed to talk and an incomplete program message was received.
-430	Query DEADLOCKED  Indicates that a condition causing an DEADLOCKED Query error occurred. (See IEEE 488.2, 6.3.1.7); for example, both input buffer and output buffer are full and the device cannot continue.
-440	Query UNTERMINATED after indefinite response  Indicates that a query was received in the same program message after an query requesting an indefinite response was executed. (See IEEE 488.2, 6.3.7.5).

---

## Instrument Specific Error Messages

---

---

### Block Transfer Errors

- 101      – 161, “Invalid block data;Too Many Calibration Array Elements Sent(101)”  
For a specific calibration array, the HP-IB controller has sent more array elements than needed by the array definition.
- 102      – 161, “Invalid block data;Incorrect Number Of Calibration Array Elements(102)”  
For a specific calibration array, the HP-IB controller has sent an incorrect number of array elements than needed by the array definition.
- 103      – 161, “Invalid block data;Bad Learn String Checksum(103)”  
Indicates that an incoming learn string was rejected because the newly calculated checksum did not match the original checksum stored with the learn string.

---

## Bus Control Errors

- 201 -310, “System error;Another Controller Is On The HP-IB Bus(201)”  
Indicates that during a Flatness Calibration, the instrument was trying to establish the control of the Power Meter, but figured out another controller is on the HP-IB bus. Flatness Calibration is aborted.
- 204 -310, “System error;Command Send Error-No HP-IB Devices Found(204)”  
Indicates that during a Flatness Calibration, the instrument was sending a command to an HP-IB device, but could not End it. Flatness Calibration is aborted.
- 205 -310, “System error;Cannot Find Power Meter On HP-IB Bus(205)”  
Indicates that during a Flatness Calibration, the instrument was trying to establish the control of a supported Power Meter, but could not End it. Flatness Calibration is aborted.
- 206 -310, “System error;Meter Returns Error Message(206)”  
Indicates that during a Flatness Calibration, the HP-IB Power Meter error checking returns an error message of some type.
- 207 -310, “System error;Meter Data Measured Is Invalid or Out Of Range(207)”  
Indicates that during a Flatness Calibration, a reading return value which HP-IB Power Meter measured is invalid or out of range. Flatness Calibration is aborted.
- 208 -310, “System error;Unable To Receive Message From Meter(208)”  
Indicates that during a Flatness Calibration, a time out is happened while the instrument was waiting to receive a message from the Power Meter. Flatness Calibration is aborted.

---

## Parsing and Compatibility Errors

- 301 – 178, “Expression data not allowed;C[ 1-4]: No External Crystal Marker Allowed(301)”
- Indicates that one of the commands “C1”, “C2”, “C3”, or “C4” were detected while the instrument was using the HP 8350 compatible language. These commands are accepted but no action is taken because the instrument does not have this feature.
- 302 -178, “Expression data not allowed;CA: No Amplitude Crystal Marker Allowed(302)”
- Indicates that the command “CA” was detected while the instrument was using the HP 8350 compatible language. These commands are accepted but no action is taken because the instrument does not have this feature.
- 303 – 178, “Expression data not allowed;CI: No Intensity Crystal Markers Allowed(303)”
- Indicates that the command “CI” was detected while the instrument was using the HP 8350 compatible language. These commands are accepted but no action is taken because the instrument does not have this feature.
- 304 – 178, “Expression data not allowed;DP: Display Blanking is always ON(304)”
- Indicates that the command “DP” was detected while the instrument was using the HP 8350 compatible language. These commands are accepted but no action is taken because the instrument does not have this feature.
- 305 -178, “Expression data not allowed;IX, OX: No Micro Learn Strings Allowed(305)”
- Indicates that the commands “IX” or “OX” were detected while the instrument was using the HP 8350 compatible language. These commands are accepted but no action is taken because the instrument does not have this feature.

**SCPI** Error Messages

306 – 178, “Expression data not allowed;NT: Network Analyzer Trigger Ignored(306)”

Indicates that the command “NT” was detected while the instrument was using the HP 8350 compatible language. These commands are accepted but no action is taken because the instrument does not have this feature.

307 – 178, “Expression data not allowed;RP: RF Blanking Is Always ON(307)”

Indicates that the command “RP” was detected while the instrument was using the HP 8350 compatible language. These commands are accepted but no action is taken because the instrument does **not** have this feature.

308 – 178, “Expression data not allowed;SHCF: No Coarse CW Resolution Allowed(308)”

Indicates that the command “SHCF” was detected while the instrument was using the HP 8350 compatible language. These commands are accepted but no action is taken because the instrument does **not** have this feature.

309 -178, “Expression data not allowed;SHDF: No Fine CW Resolution Allowed(309)”

Indicates that the command “SHDF” was detected while the instrument was using the HP 8350 compatible language. These commands are accepted but no action is taken because the instrument does not have this feature.

310 -178, “Expression data not allowed;SHM2, SHM3: No Counter Interface(310)”

Indicates that the commands “SHM2” or “SHM3” were detected while the instrument was using the HP 8350 compatible language. These commands are accepted but no action is taken because the instrument does not have this feature.



311 – 178, “Expression data not allowed;SHSS: No Default Step Sizes Allowed(311)”

Indicates that the command “SHSS” was detected while the instrument was using the HP 8350 compatible language. These commands are accepted but no action is taken because the instrument does not have this feature.

312 -178, “Expression data not allowed;SX: No External Sweep Allowed(312)”

Indicates that the command “SX” was detected while the instrument was using the HP 8350 compatible language. These commands are accepted but no action is taken because the instrument does not have this feature.

## Diagnostics and Self-test Errors

- 401        -300, “Device specific error;Test Patch Table Overflow(401)”  
Indicates that a Self-Test Patch was requested for storage in EEPROM Patch Table, but the table already has the maximum allowed (50).
- 402        -300, “Device specific error;Illegal Test Patch Name(402)”  
Indicates that an illegal Self-Test Patch <name> has been acquired to set a Self-Test Patch in EEPROM. Node <name> must be a test node and it cannot be a menu node. Any self test whose name is preceded by \* (on the front panel display) is a self test menu. [ By convention, any name which starts with an assembly number (e.g. A4CPU, A12RFintf . . . ) is a menu. And any name that contains the word ‘Menu’ is a menu. However, not all entries were able to follow this convention due to display width limitations. ]
- 403        -222, “Data out of range;Test Patch Value Out Of Range(403)”  
Indicates that user has entered a Self-Test Patch with upper or lower limit values greater than allowed. All upper and lower limits of these Self-Test Patches must be with in the range of +32767 to -32768.
- 404        -220, “Parameter error;Incorrect Number of Parameters(404)”  
Indicates that user has entered too many or not enough parameters to complete the entry for a Self-Test Patch. Parameters required to enter a Self-Test Patch are <name>, <upperLim>, <lowerLim>, and <patchType>. Refer to the Service Manual for more information.
- 405        -330, “Self-test failed;Self Test Patches Lost(405)”  
The conditions indicated by this error are: (1) firmware has, been upgraded and the test patch table has been initialized. Refer to service documentation for the appropriate patch table entries associated with the new firmware revision. (2) SRAM and EEPROM test patch tables have been corrupted and are incorrecatable. Refer to service documentation for troubleshooting information.

- 406        -330, “Self-test failed;Self Test Patch Table Locked(406)”  
Indicates that segment 7 of the CPU board DIP switch is closed, prohibiting modification of the test patch table. Switch 7 must be in the open position to allow modification.
- 407        -330, “Self-test failed;Instrument Bus Error Occurred(407)”  
As part of the power on process, the cpu attempts to write and read a special latch on the A5 timer board to verify the integrity of the instruments data and address bus. This test has failed. Refer to service documentation for troubleshooting information.
- 408        -330, “Self-test failed;Static Ram Overflow by Firmware(408)”  
Indicates that after the instrument is up and running, a series of power on self-tests have been run and Static Ram was found to be overflowed by the program running in firmware.
- 409        -330, “Self-test failed;Static Ram Not Recovered Error(409)”  
Indicates that after the instrument is up and running, a series of power on self-tests have been run and error correction code checking has found that contents of Static Ram (SRAM) has been corrupted during power up. SRAM Calibration data and SRAM Instrument State have been cleared and are lost. The rear panel dip switch 7 can/may be set to deliberately cause this condition.
- 410        -330, “Self-test failed;Power Supply Voltage Error(410)”  
Indicates that after the instrument is up and running, a series of power on self-tests have been run and Power Supply Voltage errors were found.
- 411        -330, “Self-test failed;CPU Self Test Error On Power Up(411)”  
Indicates that after the instrument is up and running, a series of power on self-tests have been run and the CPU board tests failed.
- 412        -330, “Self-test failed;ROM Checksum Error (LOW BYTE)(412)”  
Indicates that after the instrument is up and running, a series of power on self-tests have been run and error correction code checking has found that the FLASH ROM has a low byte error.
- 413        -330, “Self-test failed;ROM Checksum Error (HIGH BYTE)(413)”

**SCPI** Error Messages

- Indicates that after the instrument is up and running, a series of power on self-tests have been run and error correction code checking has found that FLASH ROM has a high byte error.
- 414 -330, “Self-test failed;Boot-ROM Checksum Error (LOW BYTE)(414)”
- Indicates that after the instrument is up and running, a series of power on self-tests have been run and error correction code checking has found that Boot-ROM has a low byte error.
- 415 -330, “Self-test failed;Boot-ROM Checksum Error (HIGH BYTE)(415)”
- Indicates that after the instrument is up and running, a series of power on self-tests have been run and error correction haming code checking has found that Boot-ROM has a high byte error.
- 416 -330, “Self-test failed;RAM-backup battery is LOW(416)”
- Indicates SRAM-backup battery is LOW.
- 417 -330, “Self-test failed;Power Up RAM Addressing Error(417)”
- Indicates RAM Addressing Error during Power Up.
- 418 -330, “Self-test failed;Power Up RAM Test Error(LOW BYTE)(418)”
- Indicates that after the instrument is up and running, a series of power on self-tests have been run and RAM Test is found to have low byte error.
- 419 -330, “Self-test failed;Power Up RAM Test Error(HIGH BYTE)(419)”
- Indicates that after the instrument is up and running, a series of power on self-tests have been run and RAM Test is found to have high byte error.
- 420 -330, “Self-test failed;Power Up Calibration Corrupted: Default Used(420)”
- Indicates that after the instrument is up and running, a series of power on self-tests have been run and error correction code checking has found that contents of one of the calibration arrays were found corrupted. A default calibration has been used.

- 421 -330, “Self-test failed;Power Up Calibration Defaulted(421)”  
Indicates that after the instrument is up and running, a series of power on self-tests have been run and error correction code checking has found that contents of one of the calibration arrays were found corrupted. A default calibration has been used.
- 422 -330, “Self-test failed;Power Up Calibration Improved(422)”  
Indicates that after the instrument is up and running, a series of power on self-tests have been run and error correction code checking has corrected a one bit error when recovering data from the EEPROM. Proper operation of the instrument is guaranteed. It is suggested that a calibration save operation be performed to permanently correct this problem.
- 423 -330, “Self-test failed;Power Up DSP Handshake Failed(423)”  
Indicates that during the series of power on self-tests, the handshake control with the Digital Signal Processor has failed.
- 424 -330, “Self-test failed;DSP Handshake Fail During Byte Transfer(424)”  
Indicates that after the instrument is up and running, byte transfers with the Digital Signal Processor have failed.
- 430 - 120, “Numeric data error;Entered Value is not a Valid Patch Number(430)”  
Indicates that a Self-Test patch had been requested to be deleted from the eeprom Self-Test Patch Table, however, the entered value is not a valid patch number. A valid patch number is the index of the patch item in the patch table (starting at 1.) It is not the test <name>.

## Internal Hardware Errors

- 501 -300, “Device specific error;V/GHz DAC Out Of Range(501)”
- 502 -2 11, “Trigger ignored;Trigger Immediate Ignored(502)”
- 503 -211, “Trigger ignored;Sweep Trigger Immediate Ignored(503)”
- 504 -213, “Init ignored;Init Immediate Ignored(504)”
- 505 -211, “Trigger ignored;Group Execute Trigger or \*TRG Ignored(505)”

---

## Hardware Configuration Errors

- 601 -311, “Memory Error;Not Able to Recall From EEPROM: Default Used(601)”  

More than a single bit error has been detected when recovering calibration data from EEPROM. Thus, it could not be used. Default calibration data is used instead.
- 602 -311, “Memory Error;EEPROM Failure. Calibration data could not be saved(602)”  

Calibration could not be stored in EEPROM. EEPROM have been detected to have failed.
- 603 -311, “Memory Error;RECALL Was Aborted. Presetting to Fix Instrument State Used(603)”
- 604 -311, “Memory Error;SAVE/RECALL Registers Corrupted. Registers Erased(604)”
- 605 -311, “Memory Error;No Data In SAVE/RECALL Registers. RECALL Ignored(605)”

- 606      “Warning! Learn String FW Revision Not Matched(606)”  
The learn string that was received does not match the current firmware revision. It was rejected and not used.
- 607      -200, “Execution error;Execution Not Allowed. Currently In Restricted Mode(607)”  
The instrument is in a restricted mode due to either the operation of self test, or current operation of a calibration. Running of most commands is not allowed. For best results, a device clear followed by a \*rst command should be sent.
- 608      -200, “Execution error;Execution Not Allowed. Currently In Network Analyzer mode(608)”  
Frequency zero can only be executed when the instrument is in stand alone mode. When the instrument is connected to an HP 8757 or when the instrument is speaking 8350 compatibility language, frequency zero cannot be implemented. If the user attempts to implement frequency zero in these modes, an error message will be generated.

---

## Calibration Routine Errors

- 701      -300, “Device specific error;Peaking Failed(701)”  
For unspecified reasons, the CW peaking algorithms failed.
- 702      -300, “Device specific error;Peaking Never Leveled(702)”  
ALC could not achieved level power under the current conditions.
- 703      -300, “Device specific error;Instrument Not in CW Mode(703)”  
It is required that the instrument first be in CW mode before a YTF peak is executed.

**SCPI** Error Messages

- 704 -300, “Device specific error;No Sufficiently Wide Pass Band Was Found(704)”  
No sufficiently wide YTF pass band was found in the initial phase of the peaking algorithm.
- 705 -300, “Device specific error;The fine-peak phase of the peaking algorithm failed(705)”  
For unspecified reasons the later “tie peak” phase of the peaking algorithm failed.
- 706 -300, “Device specific error;SAF Tracking Failure(706)”  
The SAF tracking algorithm failed for unspecified reasons.
- 709 -300, “Device specific error;Calibration Security is LOCKED. Unable to Access Cal Data(709)”  
Current Calibration Security system is in LOCKED position. Calibration data is unable for write access. To UNLOCK the Calibration Security system, refer to the Service Guide for CPU board dip switch configuration.
- 710 -300, “Device specific error;Flatness Calibration Failed(710)”  
The Flatness calibration algorithm failed for unspecified reasons.
- 711 -300, “Device specific error;Flatness Calibration Failed (711)”  
The Flatness calibration algorithm failed due to an error in reading power from the external power meter.
- 712 -300, “Device specific error;Flatness Calibration Failed Relinquish Failure(7 12)”  
The Flatness calibration algorithm failed experienced difficulties in relinquishing control of the external power meter.
- 713 -300, “Device specific error;No Tracking With MMH(713)”  
The SAF tracking algorithm is not allowed to run under millimeter head personality. The millimeter head should be disconnected first.



- 714 -300, “Calibration Array Elements Sent In Descending Order(714)”  
A calibration correction flatness array was sent in descending order. The new array is rejected at the point of the descending element, X, which causes the array to be out of order. The previous elements, up to element X, are being written over by the new elements and cannot be restored.
- 715 -300, “Entered Password does not match the Security Password(715)”  
The user is trying to change the calibration security password and the verified password is incorrect as it does not match the system security password.
- 716 -300, “User-Defined Password must be a 5-numerical-digit(716)”  
The user is trying to change the calibration security password and the new password is not a 5-digit numerical entry.

---

## Loops Unlocked Errors

- 801 -300, “Device specific error;YIG Oscillator Unlock(801)”  
Phase lock with the YIG oscillator was lost or could not be achieved.
- 802 -300, “Device specific error;Reference Oscillator Unlock(802)”  
Phase lock with the Reference oscillator was lost or could not be achieved.
- 803 -300, “Device specific error;Fractional-N VCO Unlock(803)”  
Phase lock with the Fractional-N VCO was lost or could not be achieved.
- 804 -300, “Device specific error;Heterodyne Oscillator Unlock(804)”  
Phase lock with the Heterodyne oscillator was lost or could not be achieved.

---

## Miscellaneous Hardware Dependent Errors

- 901 -221, “Setting conflict;FNCW: Instrument Not In CW Mode(901)”
- 902 -300, “Device specific error;Need Same Attenuator Settings In Alt Sweep Mode(902)”
- When using the Alternate Sweep feature, the attenuator settings must be the same. This prevents the attenuator from being continuously switched between two different attenuation values.
- 903 -300, “Device specific error;Bad Sweep Mode, Alternate Sweep Rejected(903)”
- The instrument cannot sweep alternately with a stepped sweep as one of the sweep types.
- 904 -300, “Device specific error;Bad Magic Numbers in MM Head(904)”
- The instrument will attempt to read known constants from predefined memory locations in the mm-wave source module NOVRAM (non-volatile RAM and ROM). An error condition occurs if the constants are not read back correctly, and the instrument reverts back to its stand-alone mode.
- 905 -300, “Device specific error;Bad Checksum in MM Head(905)”
- The error condition occurs when the checksum test fails on the mm-wave source module NOVRAM. If the error occurs at power up or instrument preset, instrument will revert back to stand-alone mode.
- 906 -300, “Device specific error;MM Head ALC Test Failed(906)”
- The test checks the overall integrity of the mm-wave source source module ALC circuitry at minimum settable power for the specific module.

**———— Specifications and Options**

---

# Specifications and Options

This chapter contains listings of the sweeper performance specifications and the mechanical, electrical, warranty and documentation options that are available for the HP 83750 series sweepers.

---

# Specifications

Specifications describe the instrument's warranted performance over the 0 °C to 55 °C temperature range unless otherwise noted. Specifications apply after the peak function has been performed. (Refer to "**PEAK**" in Chapter 14 for information on performing the peak function.)

Supplemental characteristics (indicated by italics) are intended to provide information useful in applying the instrument, but are not warranted parameters.

---

## Frequency

---

## Range

HP 83751A/B: 2 GHz to 20 GHz  
HP 83752A/B: 10 MHz to 20 GHz

---

## Timebase Stability

Standard 10 MHz timebase:  $\pm 10$  ppm

High stability timebase (Option 1E5): Accuracy = Calibration  $\pm$  Aging rate  
& Temperature effects  $\pm$  Line voltage effects

Aging rate:  $5 \times 10^{-10}$ /day,  $1 \times 10^{-7}$ /year

*With temperature:  $1 \times 10^{-10}/^{\circ}\text{C}$*

*With line voltage:  $5 \times 10^{-10}$  for 10% change*

---

## CW Mode

Resolution: 1 Hz

Accuracy: same as timebase

*Switching time: 70 ms max*

---

## Stepped Sweep Mode

Resolution: Settable 1 Hz, Display 1 kHz

Accuracy: See timebase specifications

Minimum step size: Settable 1 Hz, Display 1 kHz

Number of points: 2 to 1601

*Switching time/point: 7 ms + 8 ms/GHz step (Up to 50 ms switching time can occur when crossing the 2 GHz bandswitch point.)*

Dwell time/point: 1 ms to 50 s

---

## Ramp (Analog) Sweep Mode

Resolution: 1 kHz

Accuracy ( $25 \pm 5^\circ\text{C}$ ): for 100 ms sweeps, the greater of:

$\pm 0.01\%$  of span timebase

or  $\pm 75$  kHz timebase

*at other sweep speeds:  $[\pm 0.001\% \text{ of span}] / [\text{sweep time (s)}] \text{ timebase}$*

Sweep time: 10 ms to 100 s; 400 MHz/ms max

---

## Bandswitch Points

*For spans > 100 MHz:*

*Bandswitch points at 2 and 11 GHz.*

*For ramp sweeps > 0.8 octave:*

*Bandswitch points at 3.35 and 5.9 GHz.*

Frequency

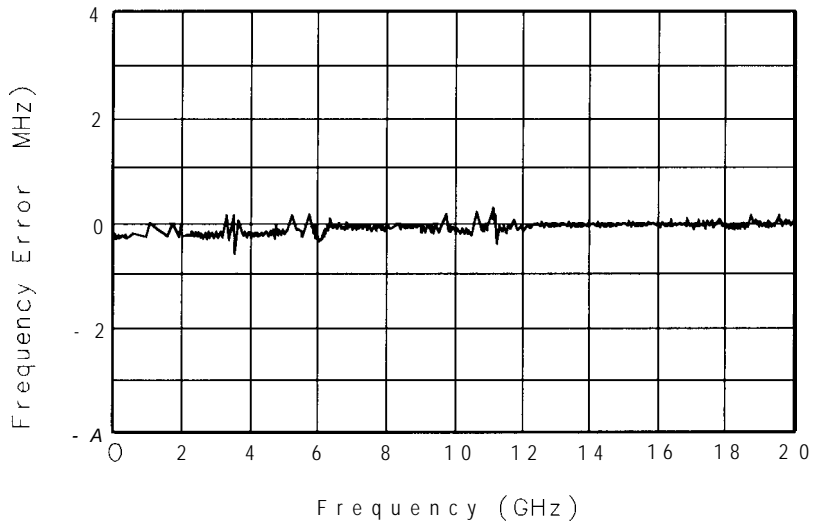

pg428ab

Figure 17-1. Typical Swept Frequency Accuracy (**100 ms sweep, ramp mode**)



# RF Output

With type-N output connector (Option 1E1), performance is typical above 18 GHz.

## Maximum Levelled Power ( $25 \pm 5^\circ\text{C}$ )

HP 8375141: + 10 dBm

HP 83752A: + 10 dBm

HP 83751B: + 17 dBm

HP 83752B: < 2 GHz, + 16 dBm;  $\geq 2$  GHz, + 17 dBm

With Option 1E1 (step attenuator): reduce by 1 dB

*Power typically degrades < 2.5 dB over 0 to 55°C*

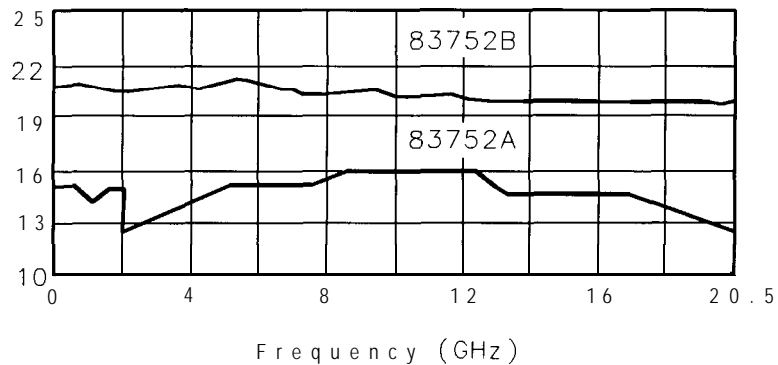

pg430ab

Figure 17-2. Typical Maximum Available Power

---

## Minimum Settable Power

HP 83751A and HP 83752A: -15 dBm  
 With Option 1E1: -85 dBm  
 HP 83751B and HP 83752B: -10 dBm  
 With Option 1E1: -80 dBm

---

## Resolution

Settable: 0.01 dB  
 Display: 0.1 dB

---

## Accuracy and Flatness

Specifications apply for coupled attenuator mode (Option 1E1) and ALC level > -10 dBm (HP 83751A and HP 83752A); > -5 dBm (HP 83752A and HP 83752B).

Model	Power Level	Accuracy*	Flatness <sup>†</sup>
HP 83751A and HP 83752A	> -10 dBm	±1.0 dB	±0.7 dB
HP 83751A and HP 83752A (with Option 1E1)	> -80 dBm	±1.5 dB	±1.2 dB
HP 83751B and HP 83752B	> -5 dBm	±1.5 dB	±1.3 dB
HP 83751B and HP 83752B (with Option 1E1)	> -75 dBm	±1.5 dB	±1.3 dB
* 25 ±5 °C			
<sup>†</sup> Below 50 MHz, flatness is specified over 25 ±5 °C range			

---

## Power Sweep

$\pm 25$  dB/sweep, maximum

Usable from minimum to maximum leveled power, within any one attenuator setting.

*Settable to  $\pm 35$  dB/sweep.*

---

## Power Slope

0 to  $\pm 2$  dB/GHz, up to power sweep limit

---

## External Leveling

External detector:

range: -0.2 mV to -0.5 V

*bandwidth (sweep speed and modulation mode dependent): 10 or 100 kHz, nominal*

*External power meter: 1 Hz bandwidth, nominal*

External mm-wave module: HP 83550 series compatible with Option 1EE

---

## User Flatness (Level) Correction

Number of points: 2 to 801 points/table

Number of tables: up to 9

Entry modes: power meter, HP-IB (Compatible with HP 437B, 438A, 70100, and SCPI compatible power meters)

## Source Match

*< 1.7: 1 SWR, (internally Leveled)*

---

# Spectral Purity

---

## Harmonics (at max leveled power)

Model	Frequency	Harmonic Level
HP 83751A and HP 83752A:	10 MHz to 1.5 GHz	-30 dBc
	1.5 GHz to 20 GHz	-45 dBc
HP 83751B and HP 83752B:	All	-20 dBc

---

## Subharmonics

None

---

## Non-harmonic Spurious

This specification applies for coupled attenuator mode (Option 1E1) and ALC level  $> -10$  dBm (HP 83751A and HP 83752A),  $> -5$  dBm (HP 83752A and HP 83752B). This specification also applies for frequencies  $> 500$  kHz from the carrier, and at levels  $< +5$  dBm below 2 GHz.

Non-harmonic spurious:  $-50$  dBc

**Spectral Purity**

*Single-Sideband Phase Noise*

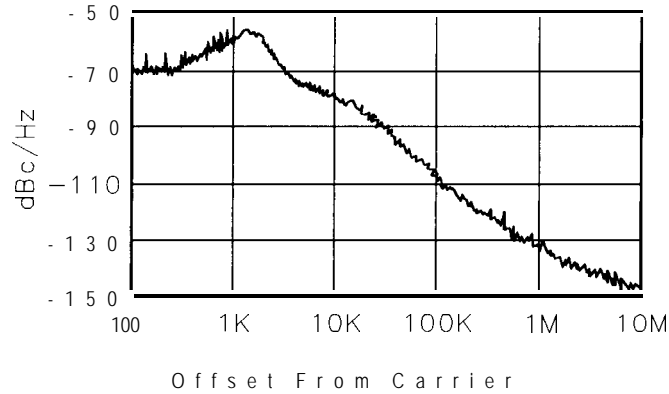

pg429ab

**Figure 17-3. Typical Phase Noise (10 GHz Carrier)**

---

## Residual FM (0.05 to 15 kHz bandwidth)

Residual FM: 1 kHz RMS in CW mode

*Residual FM is typically < 10 kHz in unlocked FM mode.*

---

# Modulation

Please note that all modulation characteristics are typical or nominal, and are *not* warranted parameters.

---

## Pulse

*On/Off ratio: 60 dB*

*Rise/Fall times:*

*0.5 to 2 GHz: 15 ns*

*2 to 20 GHz: 100 ns rise, 50 ns fall*

*Minimum leveled width: 2  $\mu$ s (for frequencies > 500 MHz in CW mode, or > 2 GHz in swept mode.)*

*Internal pulse generator:*

*Width range: 1  $\mu$ s to 65 ms*

*Period range: 2  $\mu$ s to 65 ms*

*Resolution: 1  $\mu$ s*

*Internal square wave: 1.0 kHz and 27.8 kHz (scalar mode)*

---

## AM

*Sensitivity: 1 dB/V*

*Bandwidth (3 dB): > 100 kHz, usable to 1 MHz*

*Depth for HP 8375XA: 20 dB; (+ 10 dBm to -10 dBm)*

*Depth for HP 8375XB: 22 dB; (+ 17 dBm to -5 dBm)*

*Input impedance: 3.5 kohms*

**Modulation**

---

## FM

*AC/Locked mode:*

*Rates: 50 kHz to 10 MHz*

*Maximum deviation: same as unlocked mode up to 25 times the rate*

*DC/Unlocked mode:*

*Rates: DC to 10 MHz*

*Maximum deviation:*

*DC to 100 Hz rates:  $\pm 75$  MHz*

*100 Hz to 1 MHz rates:  $\pm 7$  MHz*

*1 MHz to 2 MHz rates:  $\pm 5$  MHz*

*2 MHz to 10 MHz rates:  $\pm 1$  MHz*

*Sensitivity: -6 or -20 MHz/V (See Chapter 15, "Special Functions," for FM sensitivity with millimeter head use.)*

*Input impedance: 1 kohm*



---

## General

---

### Compatibility

HP 83751 and HP 83752 sweepers are compatible with HP 8757 scalar analyzers, and HP 8970B noise figure meters.

---

### Programming

HP 83751 and HP 83752 sweepers are fully compatible with the Standard Commands for Programmable Instruments (SCPI) language. SCPI complies with IEEE 488.2-1987. HP 8350 mnemonics have also been implemented to provide compatibility with ATE systems which include an HP 8350B sweeper.

---

### Master/Slave (two-tone) Measurements

Two HP 83750 series sweepers can synchronously track each other over swept or stepped frequencies at any fixed- or swept-frequency offset with limitations. Refer to Chapter 6, "Operating a Master/Slave Setup," for information on instrument setups and operation.

---

## Environmental

Operating temperature range: 0 to 55 °C

Type tested to the environmental requirements of: MIL-T-28800E Class 5.

EMC: Conducted and radiated interference comply with:

EN55011 class A/CISPR-11 Class A

EN50082-1-1991

IEC 801-2/1991 4 kV CD, 8 kV AD

IED 801-3/1984 3 V/m (26-500 MHz)

IEC 801-4/1988 500 V

---

## Warmup Time

Operation: Requires 30 minutes warm-up time from cold start at 0 to 55 °C. Internal temperature equilibrium reached after 2 hour warm-up at stable ambient temperatures.

Frequency Reference (Option 1E5 only): Reference timebase is kept at operating temperature with the instrument connected to AC power.

### Attention!

Instruments disconnected from AC power for more than 24 hours require up to 30 days to achieve **timebase** aging specification. Instruments disconnected from AC power less than 24 hours require 24 hours to achieve **timebase** aging specification.

---

## Power Requirements

90-132 VAC (47-66 Hz), 103.5-126.5 VAC (380-420 Hz), or 198-250 VAC (47-66 Hz); 400 VA maximum (standby 100 VA). Optimum voltage range automatically selected.

If this instrument is to be energized via an external autotransformer for voltage reduction, make sure that its common terminal is connected to a neutral (earthed pole) of the power supply.

---

## Dimensions

133 mm high by 425 mm wide by 498 mm deep (5.25 in. high by 16.75 in. wide by 19.6 in. deep); excluding front and rear panel protrusions.

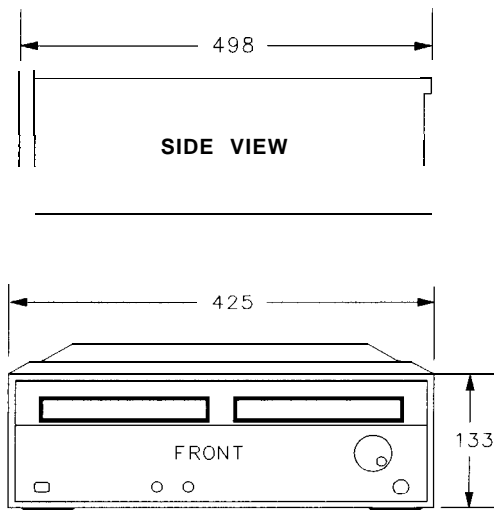

pg432ab

Figure 17.4. Dimensions

---

## Weight

Net: 16 kg (35 lb)

Shipping: 23 kg (49 lb)

---

# Options

There are several options available for the sweeper. They are explained in the following sections.

---

## Electrical Options

There are several electrical options available for the sweeper. These options are as follows:

- |  |   |
|--|---|
| Option 1E1 Add Output Step Attenuator    | If Option 1E1 is ordered, an internal step attenuator is included before the RF OUTPUT connector. The step attenuator has a range of 0 to 70 dB in 10 dB steps. The correct amount of attenuation is selected automatically by the sweeper dependent on the output power level selected. If this option is installed, you can select whether or not the step attenuator will automatically switch. (Refer to the “Special Functions” chapter, special function number 6.) |
| Option 1E4 - Rear Panel RF Output        | If Option 1E4 is ordered, the RF OUTPUT connector will be moved to the rear panel.  |
| Option 1E5 - Add High Stability Timebase | If Option 1E5 is ordered, the sweeper is shipped with a 10 MHz temperature-controlled crystal reference oscillator for increased frequency accuracy and stability. When Option 1E5 is installed, the sweeper must be connected to ac power to keep the reference oscillator at operating temperature. If the reference oscillator has not been connected to ac power (the oven is cold), the sweeper requires 30 minutes to warm up.                                      |
| Option 1ED - Type-N RF Output Connector  | If Option 1ED is ordered, the RF OUTPUT connector is a ruggedized type-N female connector instead of the standard 3.5 mm connector. When this option is installed, output power characteristics above 18 GHz are typical and not warranted.   |

## Options

Option 1EE - Source  
Module Connector and  
Extension Cable

If Option 1EE is ordered, source module interfacing hardware is added. This includes a connector on the rear panel and an extension cable that allows the mm-wave module to be positioned in front of the sweeper. This option provides direct frequency and power level control of HP 83550 series millimeter-wave source modules from the front panel of the sweeper. HP 83751A and HP 83752A sweepers require external amplification to drive source modules. High power sweeper models HP 83751B and HP 83752B can directly drive source modules.

---

## Mechanical Options

There are three mechanical options available for the sweeper. If these options were not ordered with the original shipment, and are now desired, they can be ordered from the nearest Hewlett-Packard office using the part numbers included in each of the following descriptions.

Option 1CM Rack Mount  
Kit without Handles

Ordering Option 1CM adds a rack mount kit without handles. The HP part number for the rack mount kit without handles is 5062-3977.

Option 1CP - Rack Mount  
Kit with Handles

Ordering Option 1CP adds a rack mount kit with handles. The HP part number for the rack mount kit with handles is 5062-3983.

Option AX2 - Portable  
Handle and Front-panel  
Cover

Ordering Option AX2 adds tilt-bail handle, rubber bumpers, rear feet and a protective front panel cover for Eeld test applications where portability is desired. Complies with MIL-T-28800E Class 5 Style D. The HP part number for the portability kit is 5063-0092.

---

## Warranty Options

There are five warranty options available for the sweeper. These options are as follows:

Option **W30** - Two  
Additional Years  
Return-to-HP Service

This option extends the benefits of factory warranty to provide a total of three years of customer return repair service.

Option **W50** - Five Year  
Return to HP Repair  
Service

This option extends the benefits of factory warranty to provide a total of five years of customer return repair service.

Option **W52** - Five Year  
Return-to-HP Calibration  
Service

This option provides five years of HP calibration service at HP customer service centers.

Option **W54** - Five Year  
MIL-STD Calibration  
Service

This option provides five years of MIL-STD calibration at HP customer service centers.

---

## Documentation Options

There are two documentation options available for the sweeper. If a documentation option was not ordered with the original shipment and is now desired, it can be ordered from the nearest Hewlett-Packard office using the part numbers included below:

Option OB2 - Extra  
Operating Documentation

If Option OB2 is ordered, the shipment includes an *extra* copy each of the *HP 83751A/B and HP 83752A/B Synthesized Sweepers User's Guide* (HP part number 83750-90004), *HP 83751A/B and HP 83752A/B Synthesized Sweepers Programming Guide* (HP part number 83750-90005), and the *HP 83751A/B and HP 83752A/B Synthesized Sweepers Installation and Quick Start Guide* (HP part number 83750-90006).

Option OB3 - Service  
Documentation

If Option OB3 is ordered, the shipment includes the *HP 83751A/B and HP 83752A/B Synthesized Sweepers Service Guide* (HP part number 83750-90003). Note that this document is not shipped with the sweeper if Option OB3 is not ordered.

---

## Certification Options

Option 1BN - Certification

Ordering Option 1BN provides MIL-STD 45662A certification.

Option 1BP - Certification  
with Data

Ordering Option 1BP provides MII-STD 45662A certification with a data package.



---

Safety and Regulatory  
Information

---

# Safety and Regulatory Information

This chapter includes required regulatory and safety information that is not included elsewhere in the manual. The first part of this chapter includes regulations and licensing information including the Manufacturer's Declaration of Conformity. The second part of the chapter contains required safety information that is not included elsewhere in the manual.

---

## Notice for Germany: Noise Declaration

LpA < 70 dB  
am Arbeitsplatz (operator position)  
normaler Betrieb (normal position)  
nach DIN 45635 T. 19 (per ISO 7779)

**DECLARATION OF CONFORMITY**  
**according to ISO/IEC Guide 22 and EN 45014**

**Manufacturer's Name:** Hewlett-Packard Co.

**Manufacturer's Address:** 1400 Fountaingrove Parkway  
Santa Rosa, California 95403  
U.S.A.

**Declares that the product:**

Product Name: Synthesized Sweeper

Model Numbers: HP 83751A

Product Options: This declaration covers all options  
of the above products.

**Conforms to the following product specifications:**

Safety: CAN/CSA-22.2 No. 231 Series M89

EMC: EN 55011 (1991)/CISPR 11(1990) Group 1 Class A  
EN 50082-1(1992)  
IEC 801-2(1991), 4 kV CD, 8 kV AD  
IEC 801-3(1984), 3 V/m (27-500 MHz)  
IEC 801-4(1988), 500 V signal, 1000 V AC

**Supplementary Information: The HP 83751A was qualified as part of a product family which includes the HP 83751B, HP 83752A, and HP 83752B.**

Santa Rosa, California

**Location**

2-24-93

**Date**

  
**Dixon Browder / QA Manager**

**DECLARATION OF CONFORMITY**  
**according to ISO/IEC Guide 22 and EN 45014**

**Manufacturer's Name:** Hewlett-Packard Co.

**Manufacturer's Address:** 1400 Fountaingrove Parkway  
Santa Rosa, California 95403  
U.S.A.

**Declares that the product:**

Product Name: Synthesized Sweeper

Model Numbers: HP 837518

Product Options: This declaration covers all options  
of the above products.

**Conforms to the following product specifications:**

Safety: CAN/CSA-22.2 No. 231 Series M89

EMC: EN 55011 (1991)/CISPR 11(1990) Group 1 Class A  
EN 50082-1(1992)  
IEC 801-2(1991), 4 kV CD, 8 kV AD  
IEC 801-3(1984), 3 V/m (27-500 MHz)  
IEC 801-4(1988), 500 V signal, 1000 V AC

**Supplementary Information: The HP 83751B was qualified as part of a product family which includes the HP 83751A, HP 83752A, and HP 83752B.**

Santa Rosa, California

*2-24-93*



**Location**

**D a t e**

**Dixon Browder / QA Manager**

**DECLARATION OF CONFORMITY**  
**according to ISO/IEC Guide 22 and EN 45014**

**Manufacturer's Name:** Hewlett-Packard Co.

**Manufacturer's Address:** 1400 Fountaingrove Parkway  
Santa Rosa, California 95403  
U.S.A.

**Declares that the product:**

Product Name: Synthesized Sweeper

Model Numbers: HP 83752A

Product Options: This declaration covers all options  
of the above products.

**Conforms to the following product specifications:**

Safety: CAN/CSA-22.2 No. 231 Series M89

**EMC:** EN 55011 (1991)/CISPR 11(1990) Group 1 Class A  
EN 50082-1(1992)  
IEC 801-2(1991), 4 kV CD, 8 kV AD  
IEC 801-3(1984), 3 V/m (27-500 MHz)  
IEC 801-4(1988), 500 V signal, 1000 V AC

**Supplementary Information: The HP 83752A was qualified as part of a product family which includes the HP 83751A, HP 83751B, and HP 83752B.**

Santa Rosa, California

**Location**

2-24-93

**Date**



**Dixon Browder / QA Manager**

**DECLARATION OF CONFORMITY**  
**according to ISO/IEC Guide 22 and EN 45014**

**Manufacturer's Name:** Hewlett-Packard Co.

**Manufacturer's Address:** 1400 Fountaingrove Parkway  
Santa Rosa, California 95403  
U.S.A.

**Declares that the product:**

Product Name: Synthesized Sweeper

Model Numbers: HP 837528

Product Options: This declaration covers all options  
of the above products.

**Conforms to the following product specifications:**

Safety: CAN/CSA-22.2 No. 231 Series M89

EMC: EN 55011 (1991)/CISPR 11(1990) Group 1 Class A  
EN 50082-1(1992)  
IEC 801-2(1991), 4 kV CD, 8 kV AD  
IEC 801-3(1984), 3 V/m (27-500 MHz)  
IEC 801-4(1988), 500 V signal, 1000 V AC

**Supplementary Information: The HP 83752B was qualified as part of a product family which includes the HP 83751A, HP 83751B, and HP 83752A.**

Santa Rosa, California

**Location**

2-24-93

**Date**

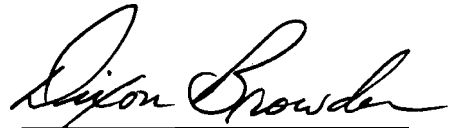

**Dixon Browder / QA Manager**

---

# Safety Information

---

---

## Statement of Compliance

This instrument has been designed and tested in accordance with IEC Publication 348, Safety Requirements for Electronic Measuring Apparatus, and has been supplied in a safe condition. The instrument instruction manuals contain information and warnings which must be followed by the user to ensure safe operation and to retain the instrument in a safe condition.

---

## Environmental Conditions

The HP 83750 series synthesized sweepers may be operated safely if the following environmental conditions are met:

- Indoor use
- Altitude up to 2000 m
- Temperature 5 °C to 40 °C
- Maximum relative humidity: 80% for temperatures up to 31 °C decreasing linearly to 50% relative humidity at 40 °C
- Mains supply voltage fluctuations not to exceed the specified range
- Pollution degree 2 according to IEC 664
- Transient overvoltages according to Installation Category II according to IEC 1010



---

## Ventilation Requirements

When installing the instrument in a cabinet, the convection into and out of the instrument must not be restricted. The ambient temperature (outside the cabinet) must be less than the maximum operating temperature of the instrument by 4 °C for every 100 Watts dissipated in the cabinet. If the total power dissipated in the cabinet is greater than 800 Watts then forced convection must be used.

---



## Cleaning Instructions

The connectors on the sweeper should be cleaned periodically for good connections. The cabinet should only be cleaned using a damp cloth.



---

# Index

Special characters   keys, 14-3  
 defined. xii

- 1 10 MHz REF IN connector, 7-5
- 10 MHz REF OUT connector, 7-5
- 1 kHz square wave modulation, 10-4

4 488.1 compatibility codes, 7-12

A accuracy

- power:specifications, 17-8

ac/locked FM mode, 10-7ac power requirements, 17-17active marker, 9-3

- defined, 9-3

add attenuator option, 17-19add high stability timebase option, 17-19address

- power meter, 15-18
- to set, 8-10
- to view, 8-10

ALC IN connector, 7-5alc key, 13-7**ALC MODE**  key, 13-7all off function

- markers, 9-7

ALT annunciator, 7-20alternate sweep

- to turn off, 8-11

alternate sweep function, 8-11alt n function, 8-11AM

- specifications, 17-13

AM INPUT connector, 7-5**AM MODE**  key, 10-6AM mode key, 10-6AM modulation, 10-2AM modulation modes, 10-6AM off mode, 10-6

- amplitude markers, 9-5
- analog sweep mode, 12-8
  - specifications, 17-5
- annunciators, 7-19
  - display, 7-19
  - fluorescent display, 7-19
  - LED, 7-19
- ANSI Standard MC 1.1, 7-12
- array
  - user flatness, 5-2
- ATT COUPLING, 15-11
- attenuator option, 17-19
- ATT SETTING, 15-12
- automatic leveling control mode, 13-7
- automatic sweep time, 15-8
- autotracking, 1-5, 14-10
- auxiliary interface connector, 7-8
  - pinout, 7-9

**B** blanking the display, 15-25

- BNC connectors, 7-4-7
- book conventions, xiv
- book introduction, iii, vi
- book outline, vi

**C** calibration

- flatness, 13-10

calibration security, 15-22

caution notice

- defined, xii

center frequency/CW coupling, 11-10, 15-6

center frequency key, 11-8

certification, viii

CF annunciator, 7-20

cf key, 11-8

**CF** key, 11-8

cf/span operation, 11-9

check

- confidence, 1-2-11
- operator's, 1-2-11

clearing memory, 15-23

clearing the display, 15-25

clear memory count, 15-24

coaxial connectors, 7-4-7

comma

- to change to decimal point, 15-26

command errors, 16-7

confidence check, 1-2-11

- connector
  - auxiliary interface, 7-8
  - millimeter head interface, 7-13
  - pinout:auxiliary interface, 7-9
  - source module, 7-13
- connector care, 7-15
- connectors, 7-3
  - coaxial, 7-4-7
  - damage levels, 7-4-7
  - front panel, 7-3
  - HP-IB, 7-10-12
  - impedances, 7-4-7
  - multi-pin, 7-8-15
  - rear panel, 7-3
- continuous trigger mode, 12-7
- continuous wave, 11-10
- CONTROL MODE, 15-27
- conventions, xiv
- copyright information, ii
- correction
  - user flatness array, 5-2
- cw
  - swept, 11-11
- CW annunciator, 7-20
- CW/center frequency coupling, 15-6
- CWCF auto on/off, 15-6
- cw/cf coupling, 11-10
- cw key, 11-10
- CW** key, 11-10
- CW mode
  - specifications, 17-4
- CW PEAKNG, 15-7

D data points, 12-10

- dc/unlocked FM mode, 10-7
- decimal point
  - to define, 15-26
- declaration of conformity, 18-4-7
- device-specific errors, 16-19
- dictionary reference, vi
- dimensions, 17-17
- disable entry function, 14-9
- disabling the save key, 15-24
- display, 7-16
  - left-hand, 7-17
  - right-hand, 7-18
  - showing the frequency as zeros, 15-22
- display blanking, 15-25

- documentation options, 17-22
- DP DEFIN, 15.26
- dwell time, 12-4

**E** electrical options, 17-19

- enabling the save key, 15-24
- entry keys, 14-2-10
- entry off function, 14-9
- environmental conditions, 18-8
- environmental operating conditions, 17-16
- error message
  - action required, 16-5
  - detailed description, 16-5
  - manual error number, 16-5
  - SCPI error message, 16-5
  - SCPI error number, 16-5
- error message format, 16-5
- error messages, 16-2-36
  - to view, 8-11
- error messages list, 16-5-22
- error numbers, 16-4
- errors
  - permanent, 16-2
- execution errors, 16-13
- EXT ALC annunciator, 7-21
- ext cal function, 13-9
- external am mode, 10-6
- external cal, 13-9
- external leveling, 2-2- 11
  - diode, 13-7
  - low output, 2-6
  - power meter, 13-7
  - specifications, 17-9
  - with detectors, couplers, or splitters, 2-3-5
  - with millimeter heads, 2-9
  - with power meters, 2-7
  - with source modules, 2-9
- external modulation, 10-3
- external pulse mode, 10-4
- external trigger mode, 12-7
- EXTMOD annunciator, 7-21
- extra operating documentation option OB2, 17-22
- EXT REF annunciator, 7-20

**F** factory preset conditions  
     instrument, 8-4  
 factory preset mode, 8-5  
 features  
     overview, iv  
 firmware revision  
     to view, 15-21  
 five year MIL-STD calibration service option W54, 17-21  
 five year return-to-HP calibration service option W52, 17-21  
 flatness  
     specifications, 17-8  
     user:specifications, 17-9  
 flatness calibration, 5-2, 13-10  
 flatness corrected power, 5-2-9  
 flatness correction  
     user:specifications, 17-9  
 FLTNESS ON annunciator, 7-22  
 FLTNESS ON LED. 7-22  
**FLTNESS ON/OFF** key, 13-10  
 FM  
     residual:specification, 17-12  
     specifications, 17-14  
 FM INPUT connector, 7-5  
**FM MODE** key, 10-7  
 FM mode key, 10-7  
 FM modulation, 10-2, 10-7  
 FM off mode, 10-7  
 FM SENSITIVITY, 15-19  
 frequency  
     center, 11-8  
     characteristics, 17-4  
     specifications, 17-4  
 frequency display, 7-17, 11-2  
 frequency display zeroing, 15-22  
 frequency functions, 11-2  
 frequency keys, 11-2-13  
 frequency multiplier function, 11-7  
 frequency offset function, 11-4  
 frequency standard selection, 15-13  
 frequency start key, 11-4  
 frequency stop key, 11-6  
 front and rear panel connectors, 7-3  
 front and rear panel features, 7-2-30  
 front panel display, 7-16  
 front panel features, 7-2-30  
 front panel knob, 7-26  
 front panel overview, iv  
 full self-test, 1-3  
 FULL SELFTST, 15-28

FW REVISION, 15-21

**G** general safety considerations, xiii

**H** harmonics  
    specifications, 17-1 1  
    Hewlett-Packard sales and service offices, xi  
    how to use this guide, xiv  
    HP 83550 series connector option, 17-20  
    HP-IB address  
        power meter, 15-18  
        to set, 8-10  
        to view, 8-10  
    HP-IB connector, 7-10-12  
    HP-IB connector mnemonics, 7-12  
    HP-IB extender instruments, 7-1 1  
    HP-IB interconnections, 7-11  
    HP-IB interface capabilities, 7-12  
    HP-IB lang/address switch, 7-23  
    HP-IB restrictions, 7-11  
    HP-IB status LEDs, 7-22  
    HP-IB switch settings, 7-23

**I** IEEE Standard 488 (1978), 7-12  
    initializing RAMs to zero, 15-23  
    instruction manual symbol  
        defined, xii  
    instrument language  
        to set, 15-20  
    instrument language switch, 7-23  
    instrument language switch settings, 7-24  
    instrument state keys, 8-2  
    intensity markers, 9-5  
    interface capabilities  
        HP-IB, 7-12  
    internal leveling, 13-7  
    internal modulation, 10-3  
    internal pulse mode, 10-4  
    In This Book, vi  
    INTMOD annunciator, 7-21  
    introduction  
        book, vi  
    introduction to the sweeper, iii



**K** keyboard  
    locking, 15-25  
    keypad, 14-5  
    key representations, xiv  
    knob, 7-26

**L** LANGUAGE, 15-20  
    language switch, 7-23  
    language switch settings, 7-24  
    left-hand display, 7-17  
    leveled output power check, 1-6  
    leveled power  
        maximum, 17-7  
    leveling  
        diode, 13-7  
        external, 2-2- 11  
        external:low output, 2-6  
        external:specifications, 17-9  
        external:with power meters, 2-7  
        external:with source modules, 2-9  
        internal, 13-7  
        power meter, 13-7  
        source module, 13-8  
    leveling control  
        key, 13-7  
    licensing, 18-3  
    line power switch, 7-27  
    line switch, 7-27  
    L LED, 7-22  
    L LED annunciator, 7-22  
    local key, 8-10  
    **LOCAL** key, 8-10  
    locking the keyboard, 15.25

**M** **M1→M2/SWEEP** key, 11-12  
    M1→M2 SWP annunciator, 7-22  
    M1→M2 SWP LED, 7-22  
    MAN annunciator, 7-20  
    manual outline, vi  
    manual sweep mode, 12-5  
    marker  
        active, 9-3  
    marker keys, 9-2-9  
    marker modes, 9-5  
    markers  
        all off, 9-7  
        amplitude, 9-5

- intensity, 9-5
  - off key, 9-7
  - to turn off, 9-7
  - z-mod, 9-5
- marker scrolling, 9-4
- marker sweep, 11-13
- marker sweep mode, 11-12
- marker to center frequency function, 11-8
- marker A key, 9-8
- marker viewing, 9-4
- master/slave connector, 7-8
- master/slave operation, 6-2-7
  - to set the sweeper to master or slave, 15-27
- match
  - source:specification, 17-10
- maximum leveled power, 17-7
- maximum leveled power check, 1-6
- mechanical options, 17-20
- meter
  - power:leveling, 2-7
- millimeter head interface connector, 7-13
- millimeter head leveling, 2-9
- millimeter head use, 4-2
- millimeter signal
  - to generate, 4-2
- minimum settable power, 17-8
- mk $r$  n key, 9-4
- MKR n** key, 9-4
- MKR→CF function, 11-8
- MKRS annunciator, 7-21
- MKR A annunciator, 7-22
- MKR Δ** key, 9-8
- MKR A LED, 7-22
- mk $r$  A ref function, Q-Q
- mm-wave head option, 17-20
- modulation
  - AM, 10-6
  - AM:specifications, 17-13
  - FM, 10-7
  - FM:specifications, 17-14
  - pulse:specifications, 17-13
  - specifications, 17-13
- modulation keys, 10-2-7
- module
  - source:leveling, 2-9
- MSG annunciator, 7-21
- msg key, 8- 11
- MSG** key, 8- 11
- MULT annunciator, 7-20

- multi-pin connectors, 7-8-15
- multiplier
  - frequency, 11-7

**N** noise

- phase:specification, 17-12
- noise declaration, 18-3
- non-harmonic spurious
  - specification, 17-11
- number of points, 12-10
- number pad keys, 14-5
- numeric entry, 14-5

**O** off key

- markers, 9-7
- OFF** key, 9-7
- offset
  - frequency, 11-4
  - power, 13-3
  - volts per GHz, 15-16
- OFFSET annunciator, 7-21
- operating conditions
  - environmental, 17-16
- operating environment, 17-16
- operator's check, 1-2-11
- option 1E1, 17-19
- option 1E4, 17-19
- option 1E5, 17-19
- option 1ED, 17-19
- option 1EE, 17-20
  - connector, 7-13
- option OB2 extra operating documentation, 17-22
- option OB3 service documentation, 17-22
- options, 17-19
  - documentation, 17-22
  - electrical, 17-19
  - mechanical, 17-20
  - rack mount, 17-20
  - warranty, 17-21
- option W30 three years return-to-HP service, 17-21
- option W50 five year return-to-HP calibration service, 17-21
- option W52 five year return-to-HP cal service, 17-21
- option W54 five year MIL-STD calibration service, 17-21
- oscillator
  - reference:specifications, 17-4
- outline of manual, vi
- output connector option, 17-19
- output power

- specifications, 17-7
- output power calibration, 13-9
- output power check, 1-8
- output power level, 13-3
- output power switch, 14-7
- overview of sweeper, iii

**P** panel

- front and rear, 7-2-30
- peaking, 1-5, 14-10
- peak power function, 14-10
- peak power tracking, 1-5
- performance specifications, 17-2
- period
  - pulse function, 10-5
- permanent errors, 16-2
- phase noise
  - single-sideband:specification, 17-12
- physical dimensions, 17-17
- pinout
  - auxiliary interface, 7-9
- points, 12-10
- power
  - flatness corrected, 5-2
  - maximum leveled, 17-7
  - maximum leveled check, 1-6
  - minimum settable, 17-8
  - output check, 1-8
  - specifications, 17-7
- power accuracy
  - specifications, 17-8
- power cable configurations, 7-29
- power cables, 7-29
- power calibration, 13-9
- power key, 14-7
- power keys, 13-2-10
- POWER LEVEL** key, 13.3
- power meter
  - leveling, 2-7
- power meter address, 15-18
- power meter leveling, 13-7
- power meter selection, 15-17
- power offset, 13-3
- power requirements, 17-17
- power resolution specifications, 17-8
- power slope, 13-3, 13-6
  - specification, 17-9
- power sweep, 13-3

- specification, 17-9
- POWER/SWEEP** key, 13-5
- power switch, 7-27
- preset conditions
  - instrument, 8-4
- preset key, 8-4
- PRESET** key, 8-4
- preset mode, 8-5
- programming
  - compatibility, 17-15
- PULSE IN/OUT connector, 7-5
- PULSE MODE** key, 10-4
- pulse mode key, 10-4
- pulse modulation, 10-2, 10-4
  - scalar mode, 10-4
  - specifications, 17-13
- pulse modulation off, 10-4
- pulse period function, 10-5
- pulse width function, 10-6
- PWR METER AD, 15-18
- PWR METER TY, 15-17
- PWR SWP annunciator, 7-21

Q query errors, 16-21

**R** rack mounting options, 17-20

- ramp sweep mode
  - specifications, 17-5
- range
  - frequency specifications, 17-4
- R annunciator, 7-22
- rear panel
  - HP-IB lang/address switch, 7-23
- rear panel features, 7-2-30
- rear panel language switch, 7-23
- rear panel RF output option, 17-19
- recalling instrument states, 8-8
- recall key, 8-8
- (RECALL\_)** key, 8-8
- reference oscillator
  - specifications, 17-4
- reference oscillator selection, 15-13
- regulatory information, 18-2-9
- residual FM
  - specification, 17-12
- resolution
  - power specifications, 17-8

- restrictions
  - HP-IB, 7-11
- RF OFF annunciator, 7-21
- RF ON/OFF** key, 14-7
- RF output
  - specifications, 17-7
- RF output connections, 7- 15
- RF OUTPUT connector, 7- 15
- RF output connector option, 17-19
- RF output power
  - specifications, 17-7
- rf power calibration, 13-9
- rf power key, 13-3
- right-hand display, 7-18
- R LED annunciator, 7-22
- ROSC AUTO, 15-13
- ROSC SOURCE, 15-14
- rpg knob, 7-26

## S safety

- general considerations, xiii
- safety and regulatory information, 18-2-9
- safety notes
  - defined, xii
- sales and service offices, xi
- save key, 8-6
- SAVE** key, 8-6
- save key disabling, 15-24
- save key enabling, 15-24
- save preset function, 8-6
- save/recall register clearing, 15-23
- saving instrument states, 8-6
- saving user-defined preset, 8-6
- scale
  - volts per GHz, 15-15
- security, 15-22
- self-test, 1-3
- selftest
  - full, 15-28
- sensitivity
  - FM, 15-19
- service documentation option OB3, 17-22
- SHIFT annunciator, 7-20
- shift key, 8-3
- SHIFT** key, 8-3
- shipping weight, 17-18
- single-sideband phase noise
  - specification, 17-12

- single sweep mode, 12-10
- single trigger mode, 12-7
- SINGLE/TRIG** key, 12-10
- size, 17-17
- slave
  - to set the instrument to slave, 15-27
- slave sweeper, 6-2-7
- S LED, 7-22
- S LED annunciator, 7-22
- slope
  - power, 13-6
  - power:specification, 17-9
- SLOPE annunciator, 7-21
- source match
  - specification, 17-10
- source module connector option, 17-20
- source module interface connector, 7-13
- source module interface signal codes, 7-13- 14
- source module leveling, 2-9, 13-8
- source module use, 4-2
- source synchronization, 6-2-7
- SPAN annunciator, 7-20
- span key, 11-9
- SPAN** key, 11-9
- special function key, 8-8
- special function representations, xiv
- special functions, 15-2-28
  - ATT COUPLING, 15-11
  - ATT SETTING, 15-12
  - CONTROL MODE, 15-27
  - CWCF AUTO, 15-6
  - CW PEAKNG, 15-7
  - DP DEFIN, 15-26
  - FM SENSITIVITY, 15-19
  - FULL SELFTST, 15-28
  - FW REVISION, 15-2 1
  - LANGUAGE, 15-20
  - PWR METER AD, 15-18
  - PWR METER TY, 15-17
  - ROSC AUTO, 15-13
  - ROSC SOURCE, 15-14
  - security, 15-22
  - STEP SWPTIME, 15-9
  - SWPTIME AUTO, 15-8
  - SWPTIME LLIM, 15-10
  - V/GHz OFFSET, 15-16
  - V/GHz SCALE, 15-15
- special functions menu, 8-8
- special functions, table of, 15-4

- specifications, 17-3
- spectral purity
  - specifications, 17-1 1
- spurious
  - non-harmonic:specification, 17-1 1
- stability
  - timebase specifications, 17-4
- standard
  - time:specifications, 17-4
- standby, 7-27
- START annunciator, 7-20
- start key, 11-4
- 11-4RT** key,
- statement of compliance, 18-8
- STEP annunciator, 7-21
- step attenuator option, 17-19
- step keys, 14-3
- stepped sweep
  - to generate, 3-2
- stepped sweep mode, 12-8
  - specifications, 17-5
- stepped sweep time, 3-2
- STEP SIZE**
- step sizes
  - table, 14-3
- STEP SWPTIME, 15-9
- STOP annunciator, 7-20
- stop key, 11-6
- STOP** key, 11-6
- STOP SWEEP connector. 7-6
- subharmonics
  - specification, 17-11

17-3

- analog:specifications, 17-5
- manual, 12-5
- power, 13-5
- power:specification, 17-9
- ramp:specifications, 17-5
- SWEEP annunciator, 7-20
- sweeper at a glance, iv
- sweeper features
  - overview, iv
- sweeper introduction, iii
- sweeper overview, iii
- sweep keys, 12-2-10
- sweep mode, 12-8
  - stepped:specifications, 17-5



- SWEEP OUT connector, 7-6
- sweep rate, 12-4
- sweep time
  - step, 15-9
  - stepped, 3-2
- sweep time key, 12-4
- swept cw, 11-11
- swept frequency mode, 11-4, 11-6
- switch
  - line power, 7-27
- SWPTIME AUTO, 15-8
- SWPTIME LLIM, 15-10
- synchronization
  - source, 6-2-7
- system security, 15-22

**T** table of sales and service offices, xi

- table of step sizes, 14-3
- task reference, vi
- terminator keys, 14-6
- three years return-to-HP service option W30, 17-21
- timebase
  - option, 17-19
- timebase stability specification, 17-4
- (TIME)** key, 12-4
- time standard specifications, 17-4
- T LED, 7-22
- T LED annunciator, 7-22
- trigger
  - single, 12-10
- TRIGGER INPUT connector, 7-6
- trigger mode key, 12-7
- TRIGGER OUTPUT connector, 7-6
- (TRIG MODE ⏏)** key, 12-7
- two-tone operation, 6-2-7
- type-N connector option, 17-19

**U** UNCPLD annunciator, 7-21

- unit keys, 14-6
- UNLEV annunciator, 7-21
- unleveled check, 1-6
- unleveled mode, 13-7
- UNLOCK annunciator, 7-21
- UNLOCKED FM annunciator, 7-22
- UNLOCKED FM LED, 7-22
- user flatness, 5-2, 13-10
  - specifications, 17-9
- user preset mode, 8-5

user's guide outline, vi

- V** ventilation requirements, 18-9
  - V/GHz OFFSET, 15-16
  - V/GHz SCALE, 15-15
  - VOLTS/GHz OUTPUT connector, 7-6
  - volts per GHz
    - offset, 15-16
    - scale, 15-15
  
- W** warmup time required, 17-16
  - warning notice
    - defined, xii
  - warranted performance, 17-2
  - warranty, ix
  - warranty options, 17-21
  - warranty service, ix
  - weight, 17-18
  - width
    - pulse, 10-6
  
- Z** Z AXIS BLANK/MKRS connector, 7-7
  - zeroing the frequency display, 15-22
  - z-mod markers, 9-5